

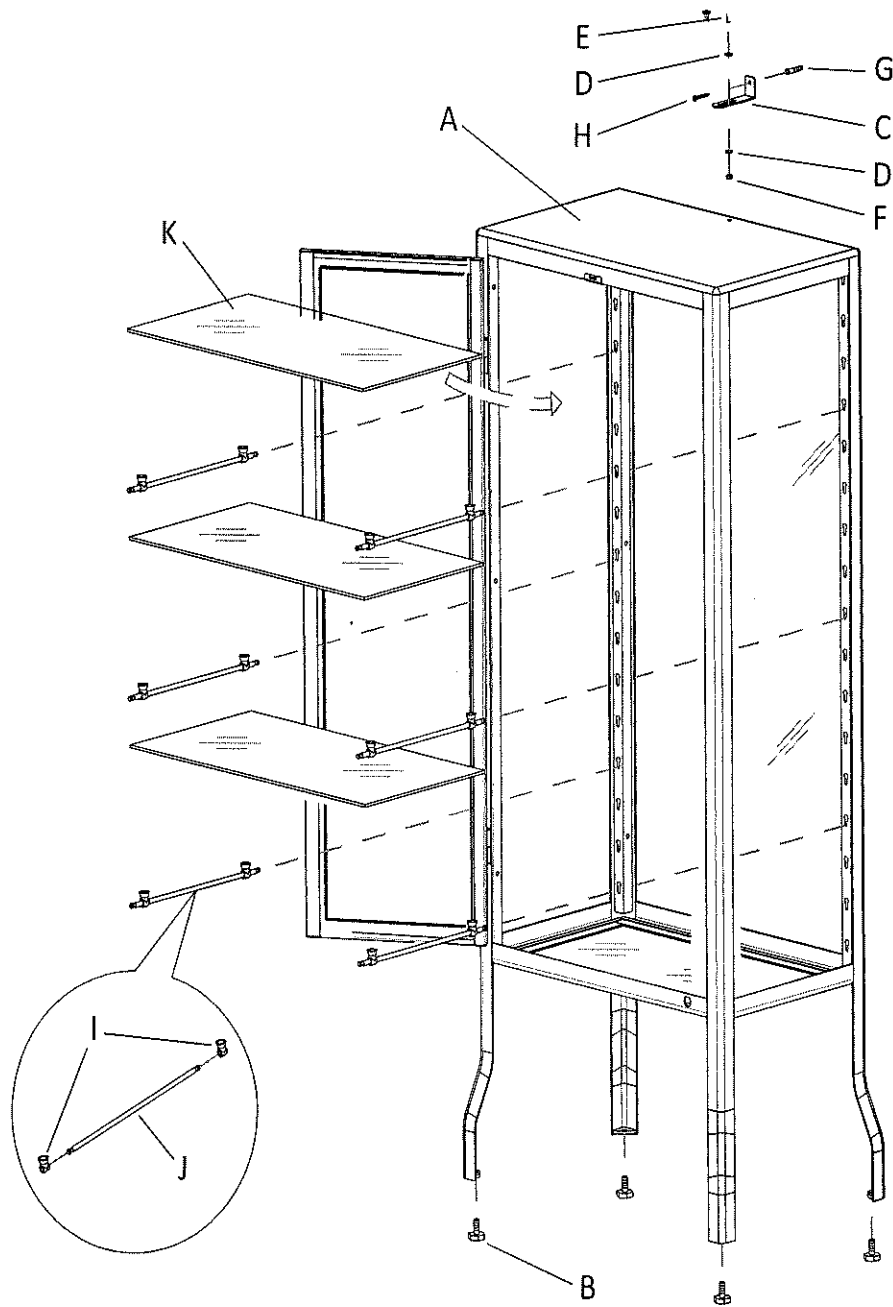

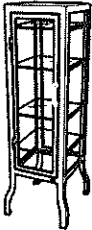







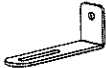

MODEL No.100-166/114-305
SHIRT CASE

6057-6058



305:415x455x1650 166:415x455x1255  Ax1PZ	 Bx4PZ	 Cx1PZ	 Dx2PZ	 M6x15 Ex1PZ	 Fx1PZ	 ø8x40 Gx1PZ
	 M5x40 Hx1PZ	 Ix16PZ	 Jx8PZ	 Kx4PZ	 Lx1PZ	 Mx1PZ