









ASSEMBLY INSTRUCTION

CP1712-F2-1651



- 
A x12
 Spec: $\phi 11.8 \times \phi 10 \times L11$
 - 
B x12
 Spec: 5/16*15
 - 
C x12
 Spec: $\phi 8 \times \phi 14$
 - 
D x1
 Spec: 5#
 - 
E x12
 Spec:
 - 
F x4
 Spec:
 - 
G x16
 Spec: $\phi 60 \times 25$
-
- 
H x8
 Spec: 048#
 - 
I x16
 Spec: $\phi 1 \times L6.5$

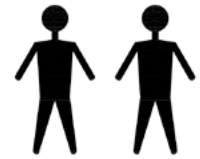

FIG.
1

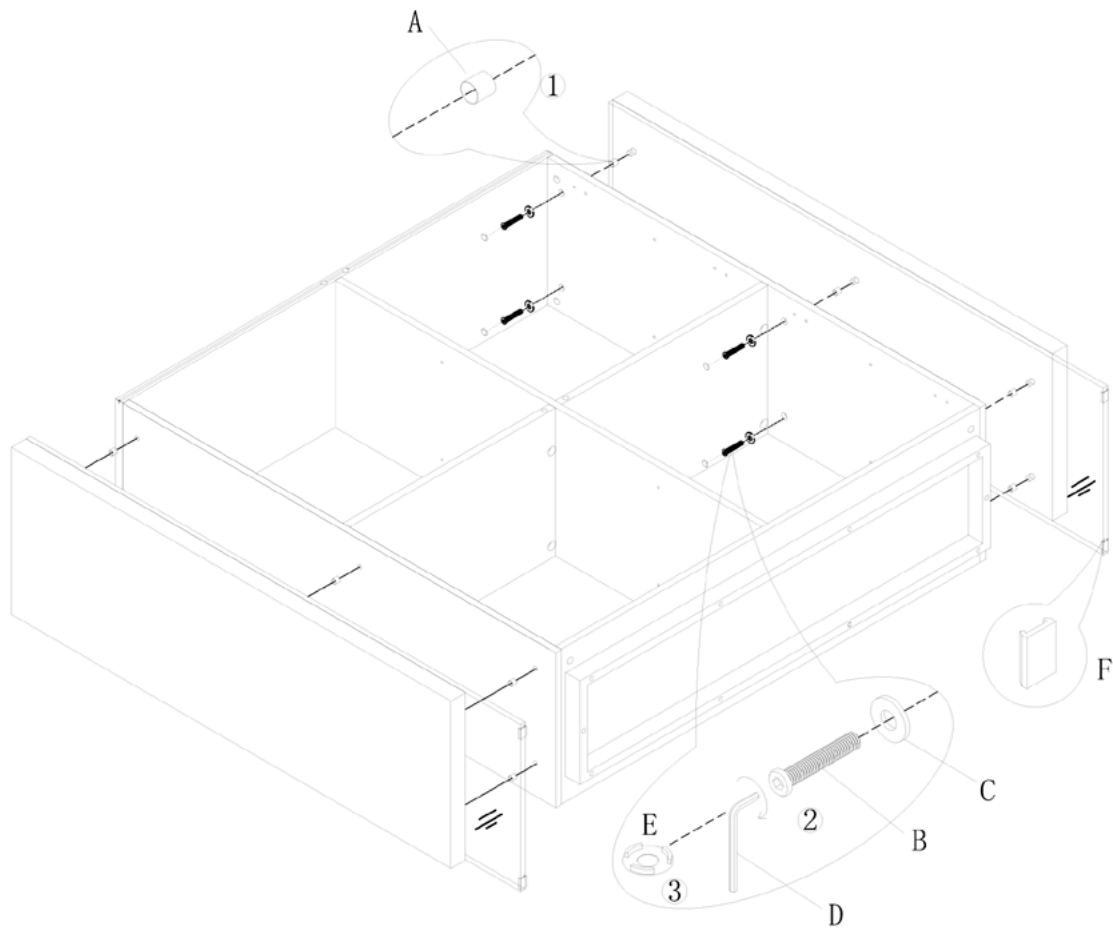

FIG.
2

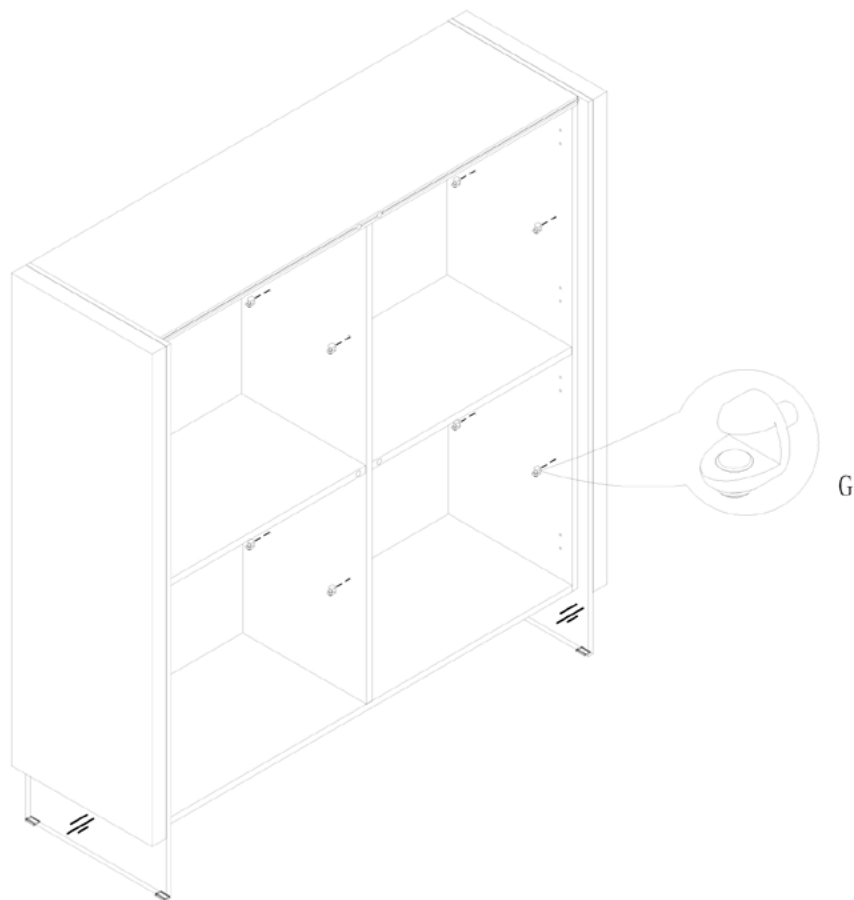

FIG.
3

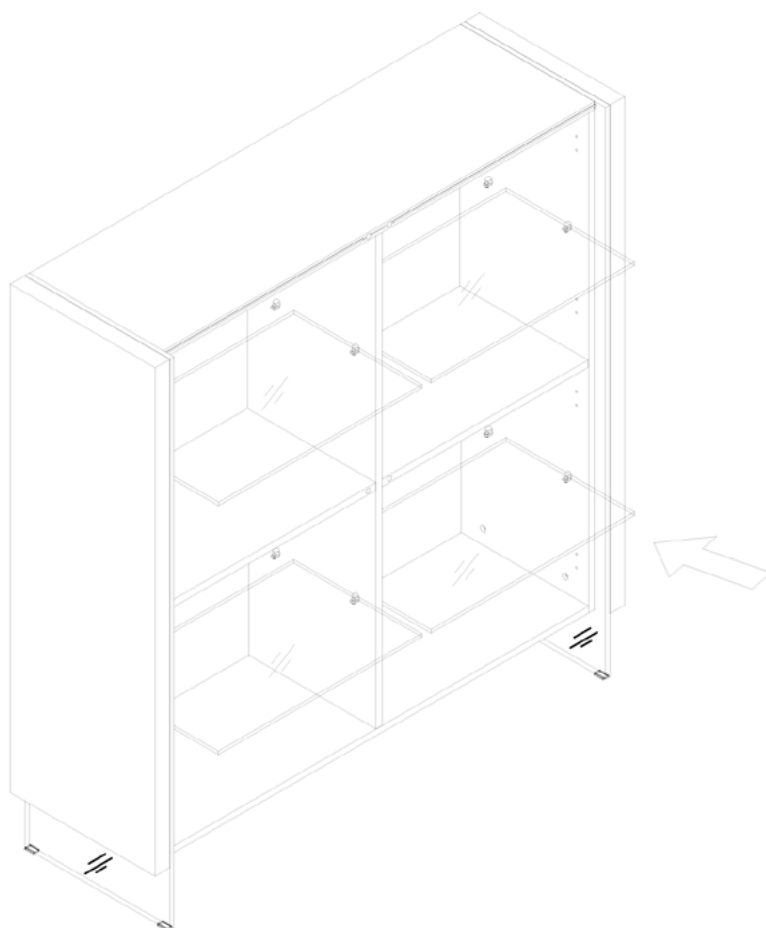

FIG.
4

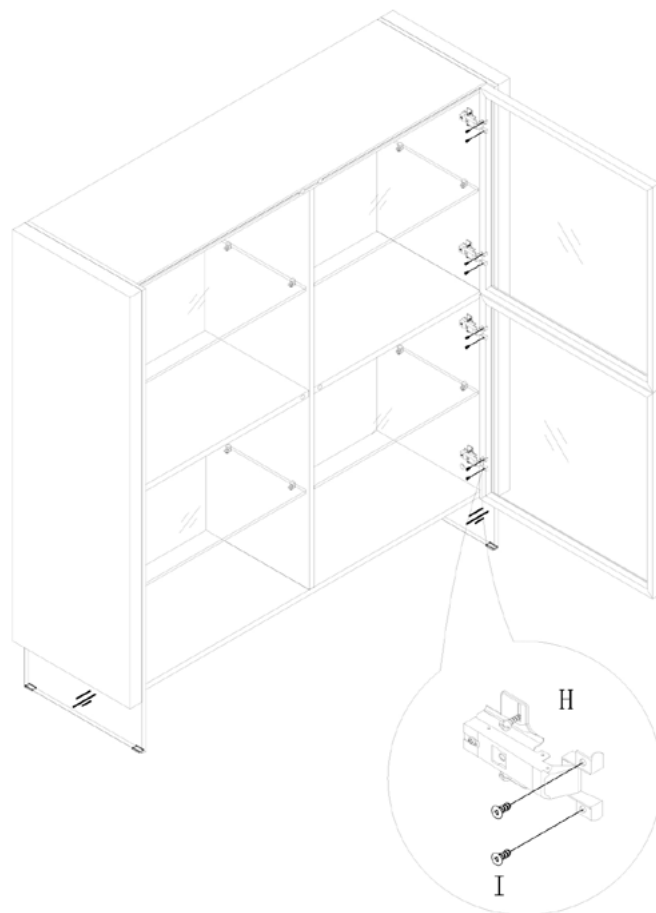

FIG.
5

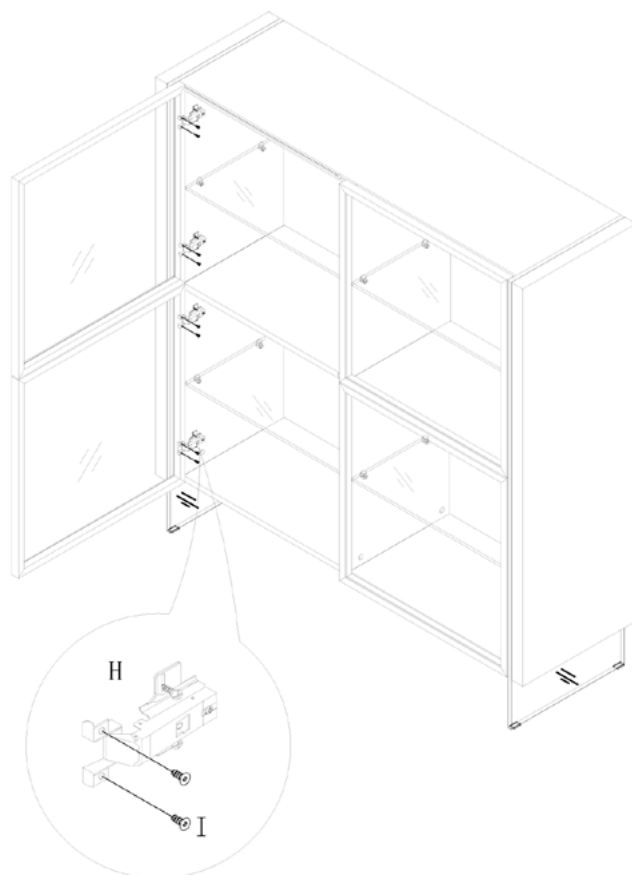

FIG.
6

