

GAMMA/ APOLLON Left Corner

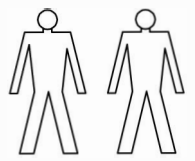

A - 1 St.

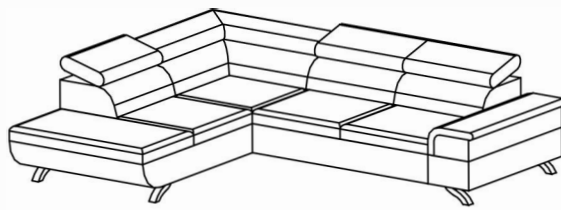

B - 1 St.



C - 4 St.



5 X 40

D - 24 St.



H: 80 mm

E - 3 St.

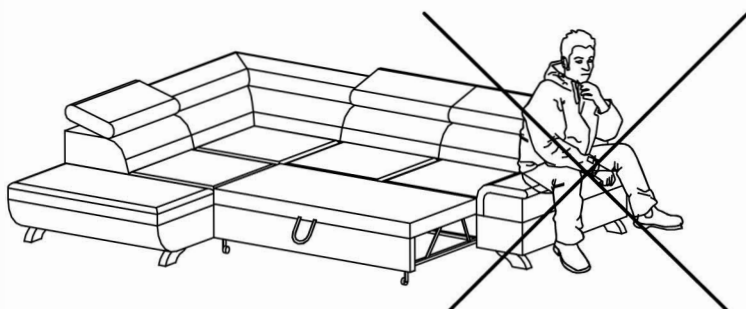
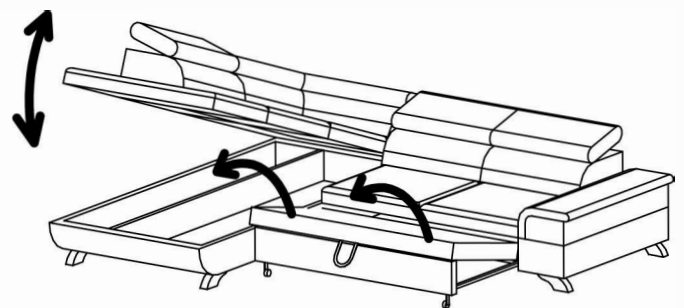
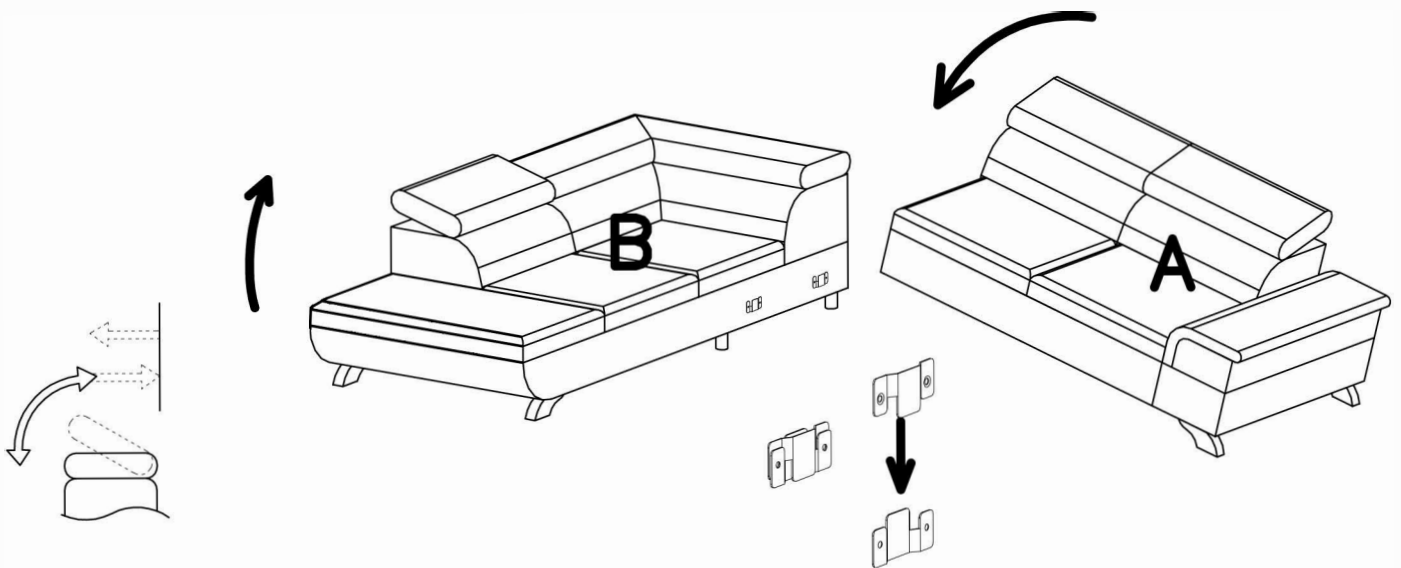
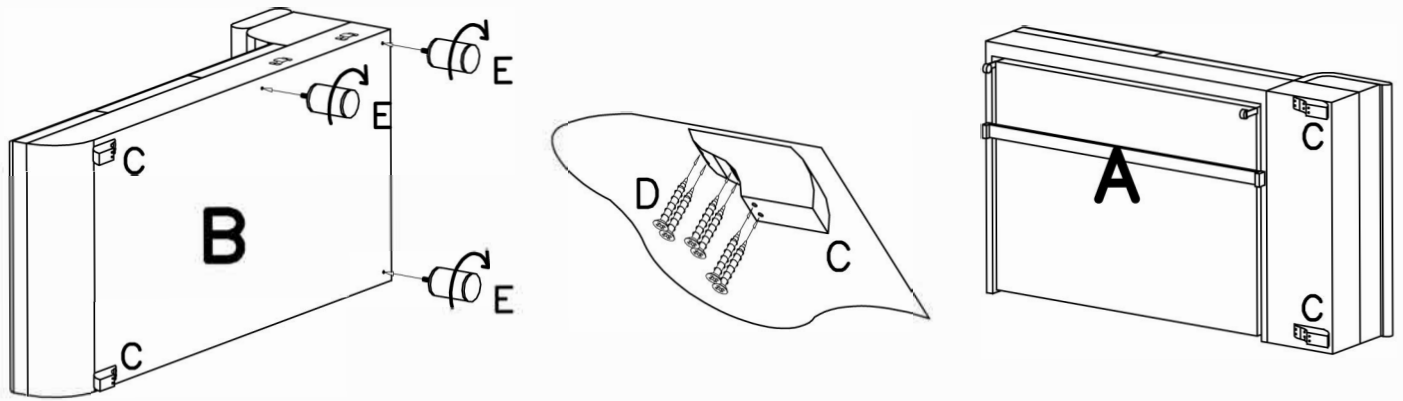

GAMMA/ APOLLON Right Corner

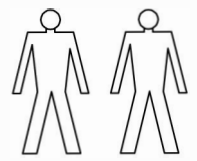
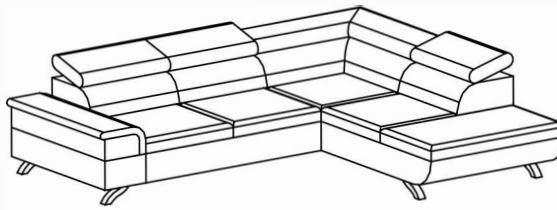

A - 1 St.

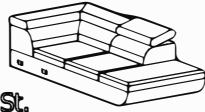

B - 1 St.

C - 4 St.



5 X 40

D - 24 St.



H: 80 mm

E - 3 St.

