

# LUPUS KOLTUK YAN SEHPA LUPUS CHAIR SIDE TABLE

---

## MONTAJ VE KULLANIM KLAVUZU ASSEMBLY MANUEL

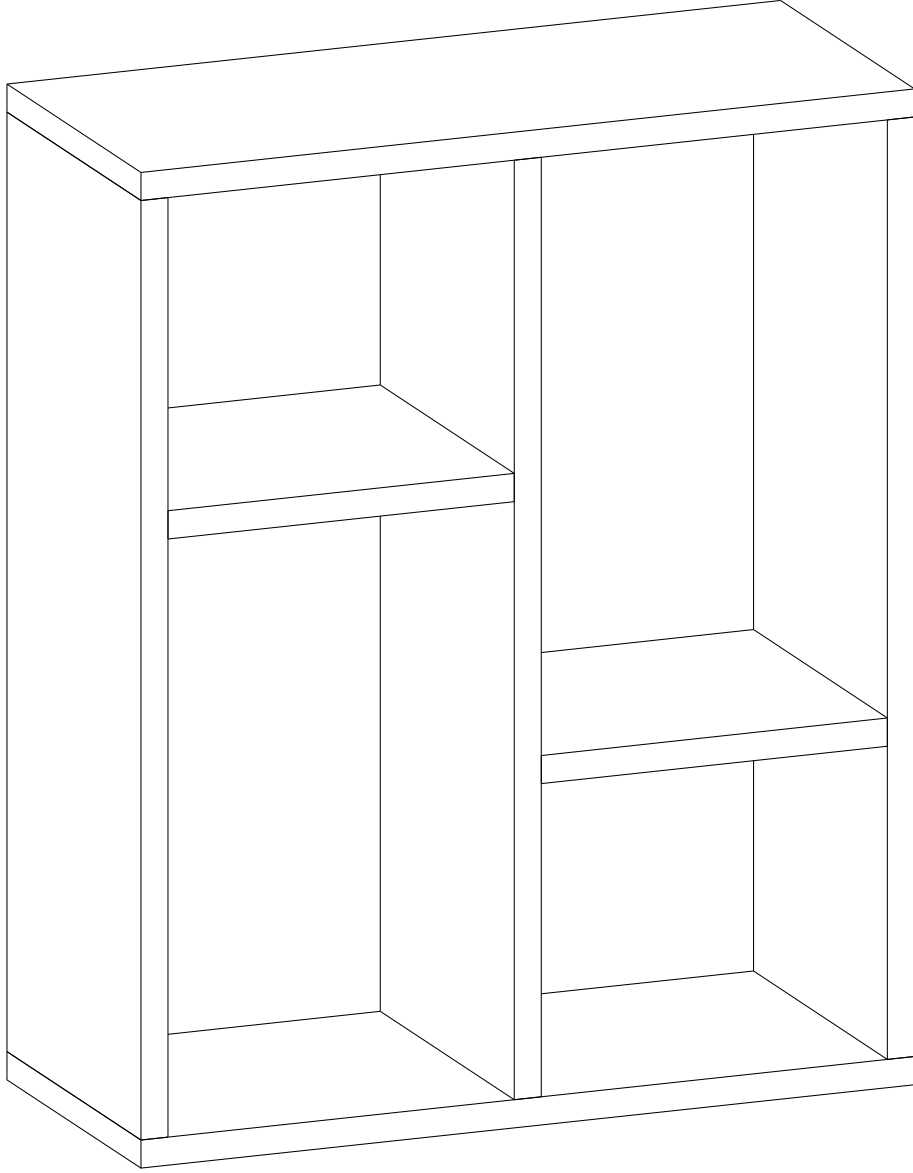

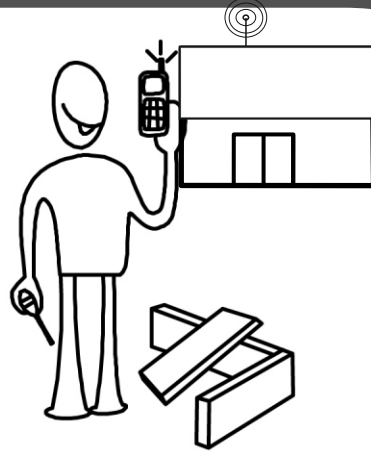
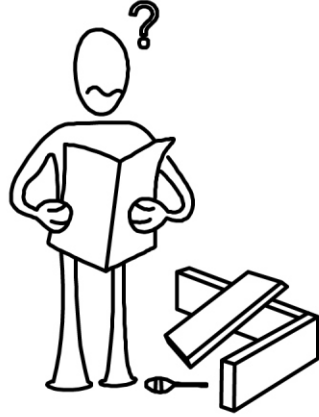
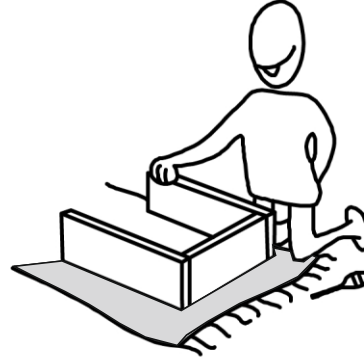
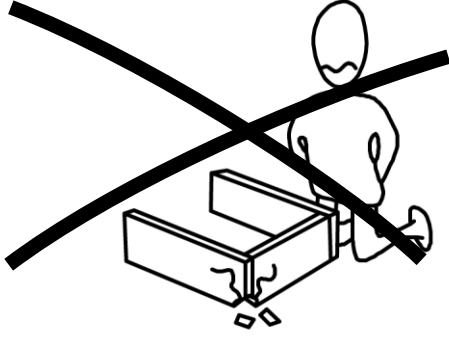
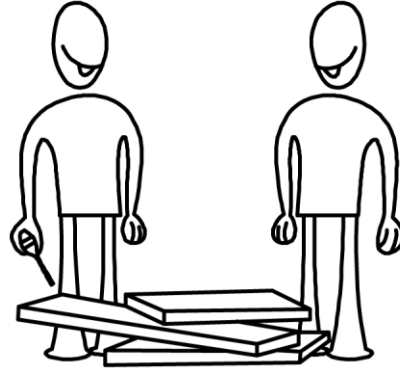
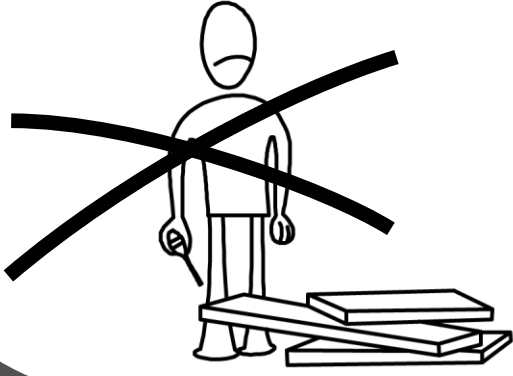

Sayın Müşterimiz,

Satınalmış olduğunuz bu ürün sizlere ulaşmadan önce tarafımızdan her türlü kontrol ve testlere tabii tutulmuştur. Bu durumda bile taşıma sırasında bazı parçaların zarar görmesi mümkündür. Böyle bir durum ile karşılaşırsanız ürünün tamamını geri göndermeyiniz. Sadece zarar gören parçayı isteyiniz. Gerekli parçayı isterken ise servis kartına bakarak tam olarak tanımlayınız. Eksik olan parça en hızlı şekilde tarafınıza gönderilecektir.

Montaja başlamadan önce kutulardan çıkan tüm parça ve aksesuarları listelere göre kontrol ediniz. Parça ve aksesuarların tam ve sağlam olduğunu tespit ettikten sonra montaja başlayınız. Montaja başlamadan önce her parçayı nemli bir bez ile temizleyiniz. Eğer birden fazla ürün aldıysanız herhangi bir karışıklığa sebep vermemek için tek bir ürün montajını yaptıktan sonra diğer ürüne geçiniz.

Ürünleri hiçbir zaman sürterek taşımayınız. Ürünü kaldırarak ve sökerek en az iki kişi ile taşıyınız. Uzun mesafeli taşımalarda ürünü mutlaka paket ile taşıyınız. Almış olduğunuz mobilyalarınızın yüzeylerinin temizlenmesi çok kolaydır. Nemli ve sabunlu bir bez ile veya diğer ev temizleyicileriyle silmek yeterlidir.

Mobilyalar aşırı sıcak, soğuk ve nemden etkilendiklerinden, mobilyanızı bu faktörlerle direkt olarak temas ettirmeyiniz. Mobilyanızı amacı dışında kullanmayınız.

Dear Customer,

The product you bought was subjected to all sorts of tests and control before sending out to you. Even in this situation, sometimes happen that some component is damaged during the transportation. In such case please do not send the whole article back to us. Just request/order the damaged part. While requesting the required part, describe it exactly by looking to service card. Missing part will be sent to you as soon as possible. Before start assembling, please check the whole components and accessories according to the lists. After being sure that every part and accessory are okay and right, start assembling. Before start assembling, please clean all the components with a damp cloth. If you bought more than one product, to prevent confusion be sure that you completed the first product. Then start the other product's assembling.

Never draw the products. While carrying, disassociate and lift the product and carry with minimum 2 people. For long distances carry the product with the package.

It is very easy to clean the surfaces of your product. It is enough to wipe with a damp and soapy cloth or other household cleaners.

Do not directly contact your furniture with excessive heat, cold and humidity because the product can be affected.

Do not use your furniture for out of purposes.

# DİKKAT !! / ATTENTION !!

Minifiks Dekorister ürünlerinde kullanılan ana bağlantı malzemesidir. Montaja başlamadan önce lütfen aşağıdaki çizimleri kontrol ederek, anlamaya çalışın...

Minifix is the main connection material used in dekorister products. Before starting assembly, please check the drawings below...

Minifix Gövde

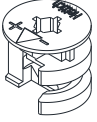

Minifix Mil



Kavela

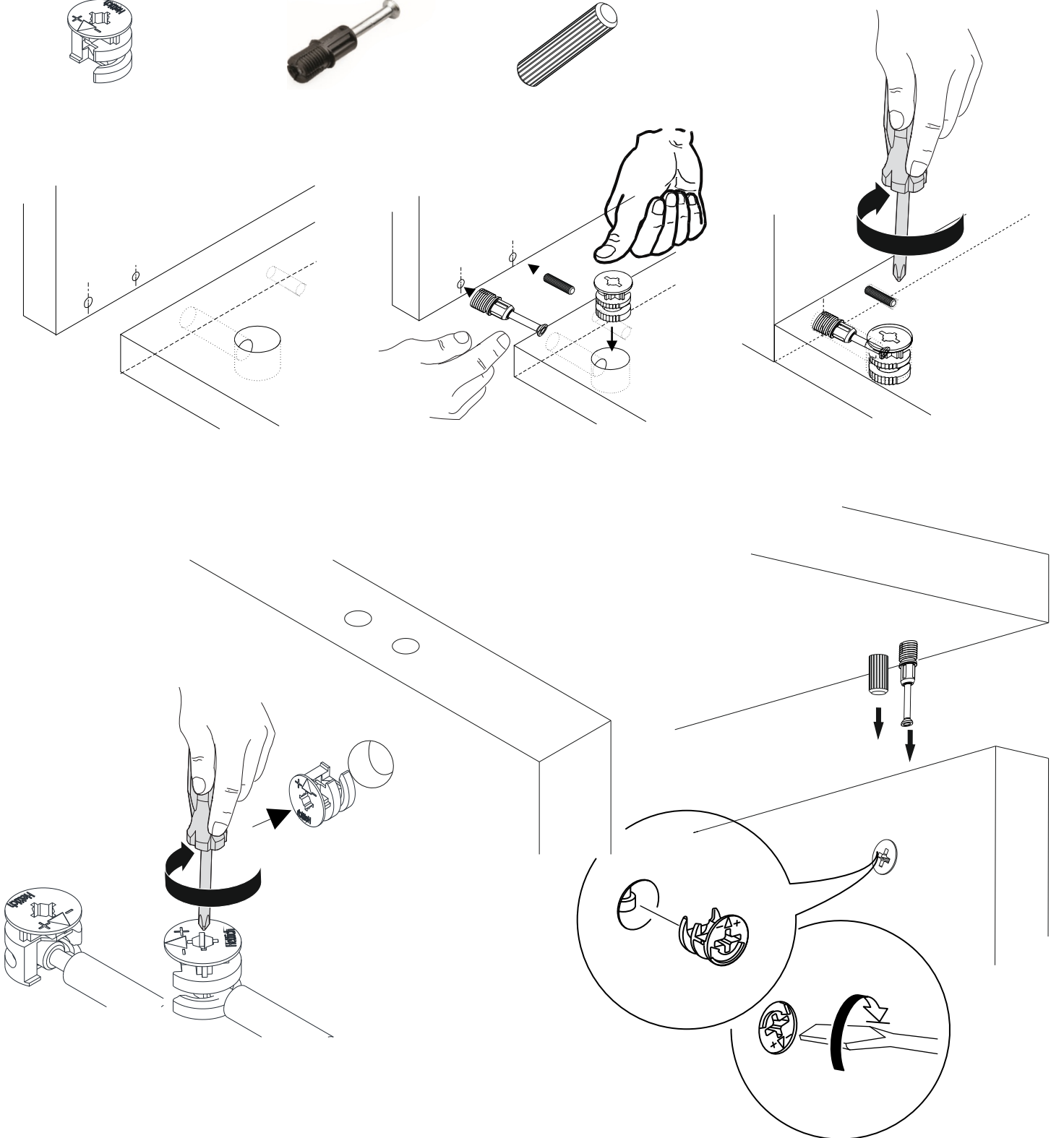
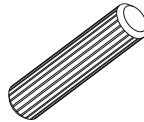

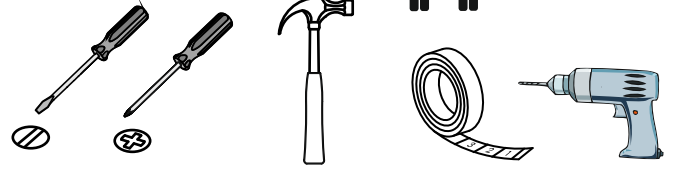
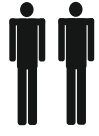

Bu modül iki kiři tarafından kurulmalıdır.  
This unit should be assembled by two persons.

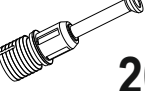

Bu modülün kurulumu için gerekli olan araçlar.

## AKSESUAR LİSTESİ / ACCESSORY LIST

<b>A01</b>  Minifix Gövde <b>20x</b>	<b>A02</b>  Minifix Mil <b>20x</b>	<b>A03</b>  Kavela <b>20x</b>	<b>A04</b>  Minifix Tapa Ana Renk <b>20x</b>
--	--	---	--

## PARÇA KODLAMA / GENERAL VIEW

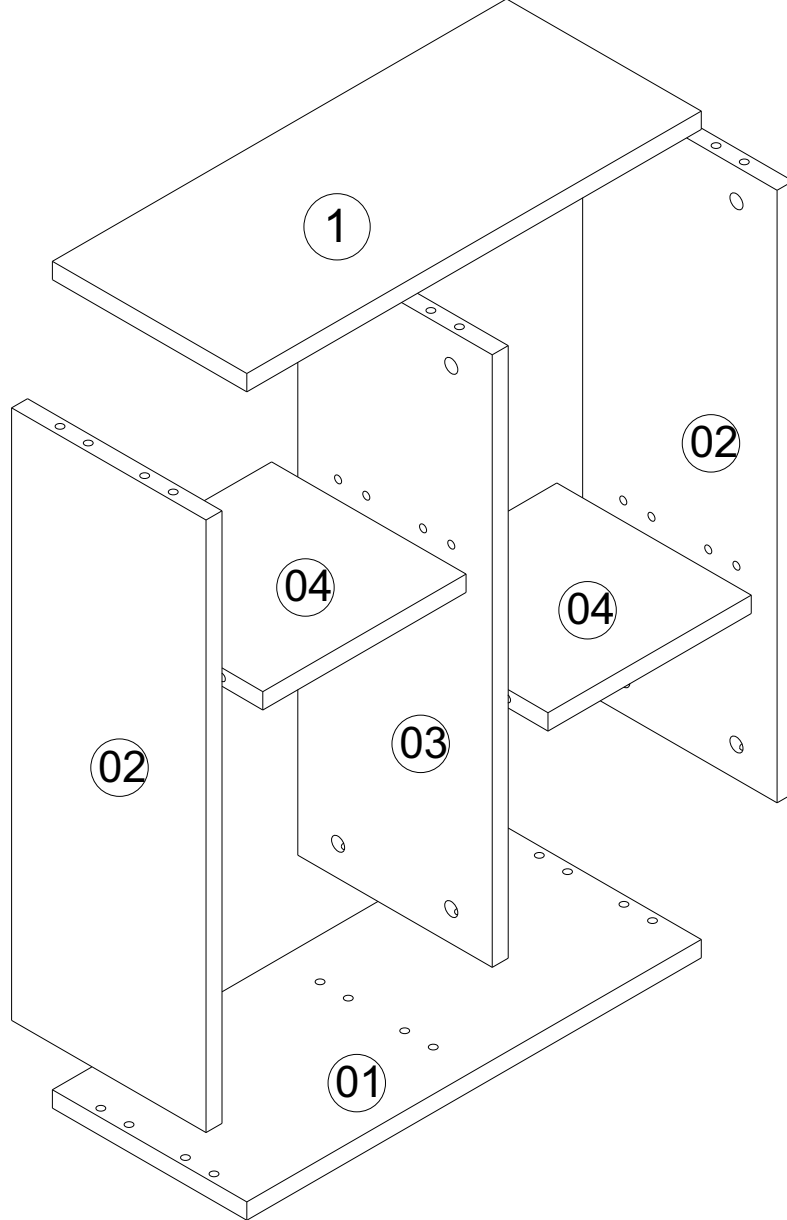

# MONTAJ KILAVUZU / ASSEMBLY MANUAL

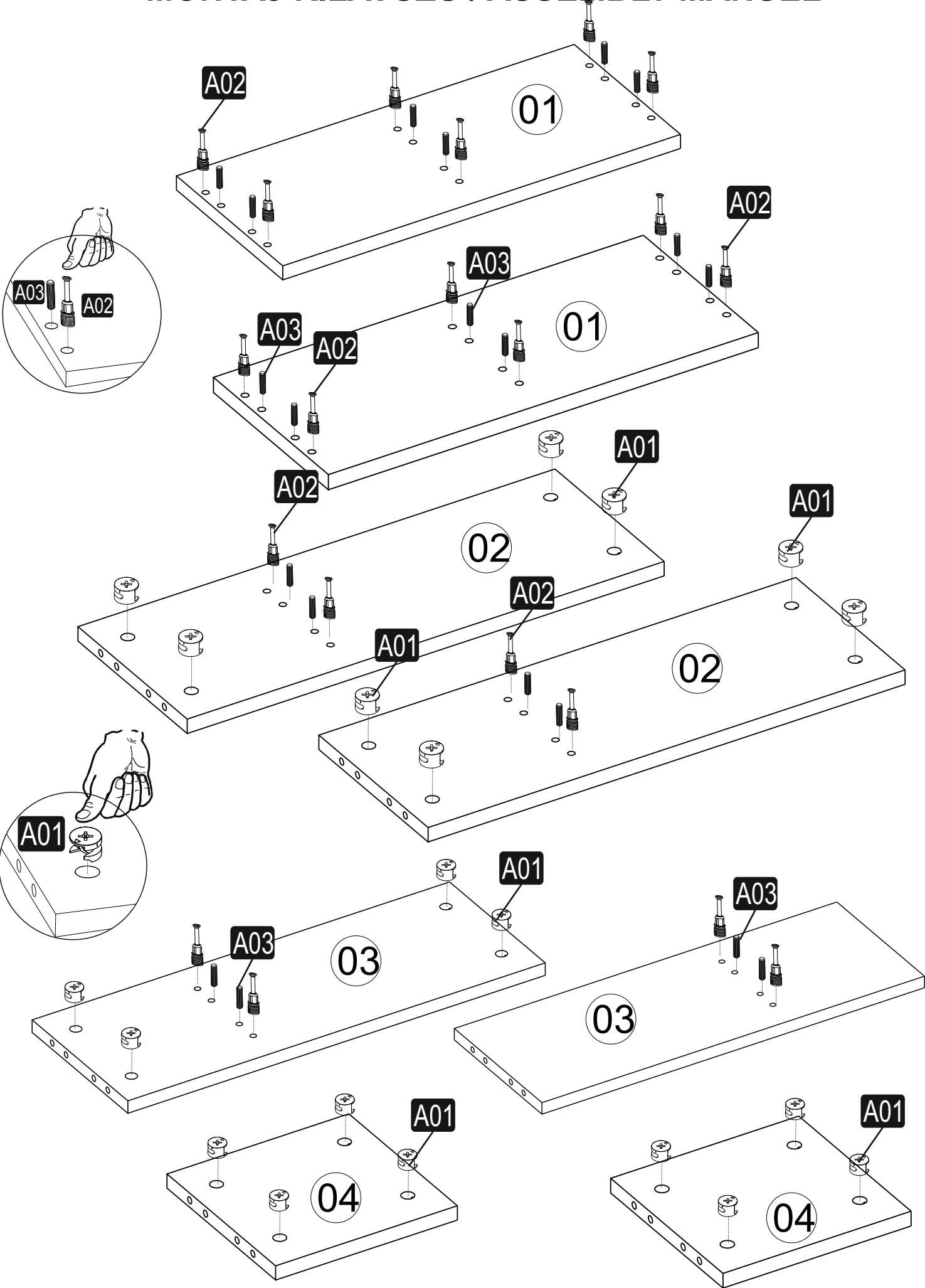

1

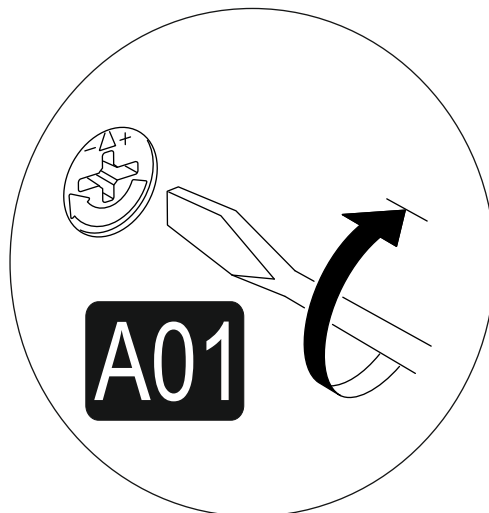
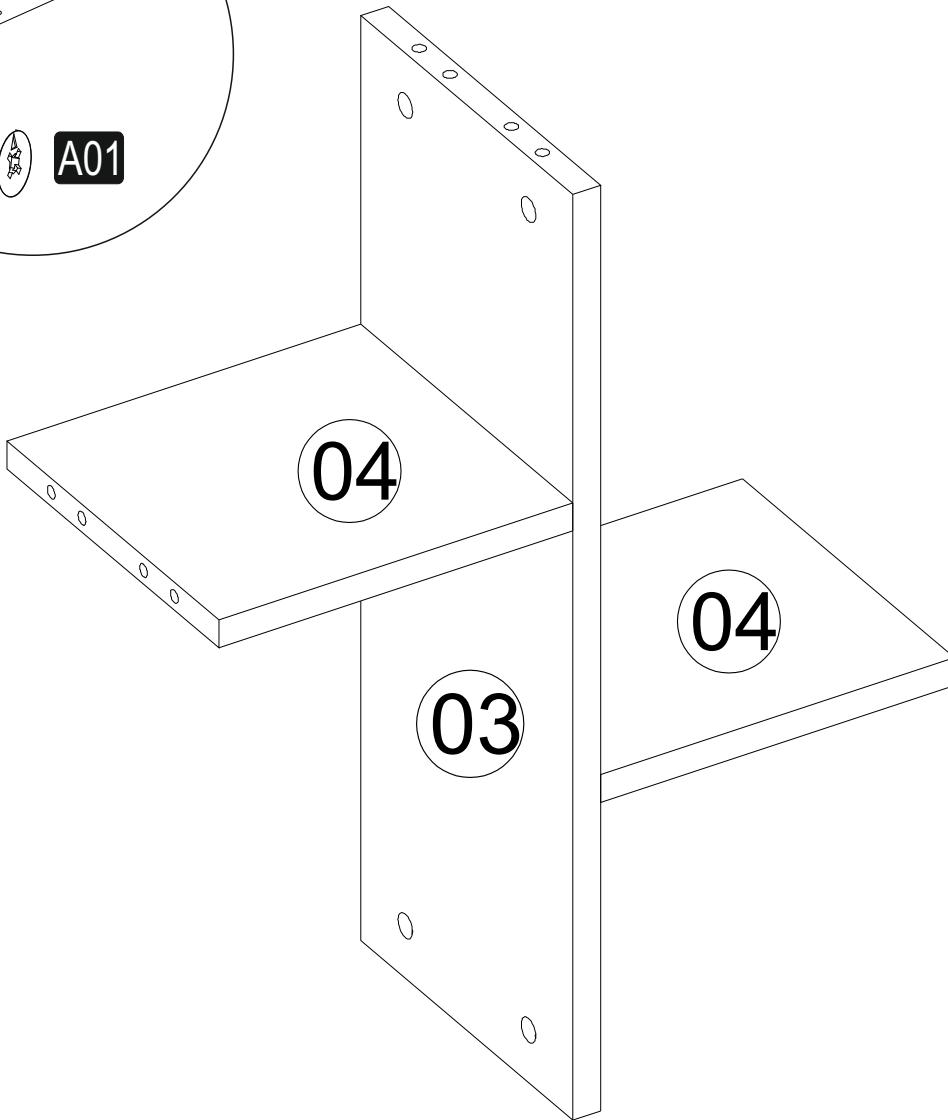
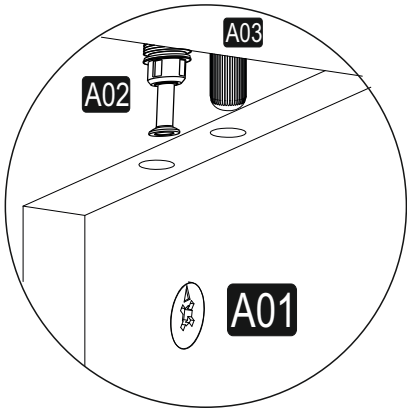

2

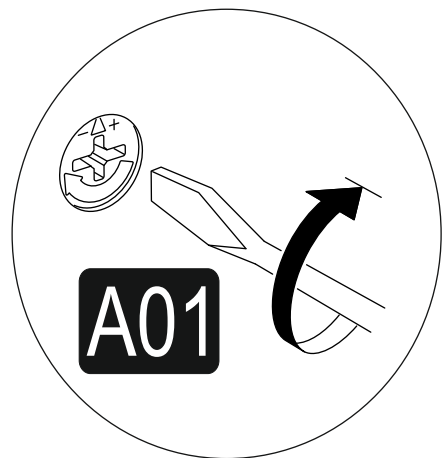
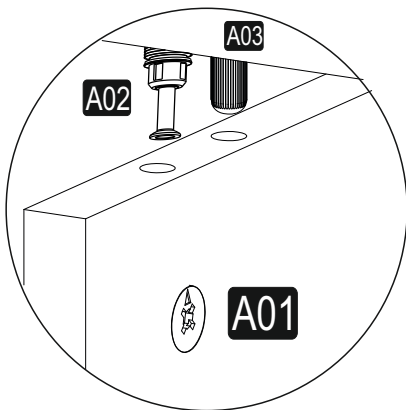
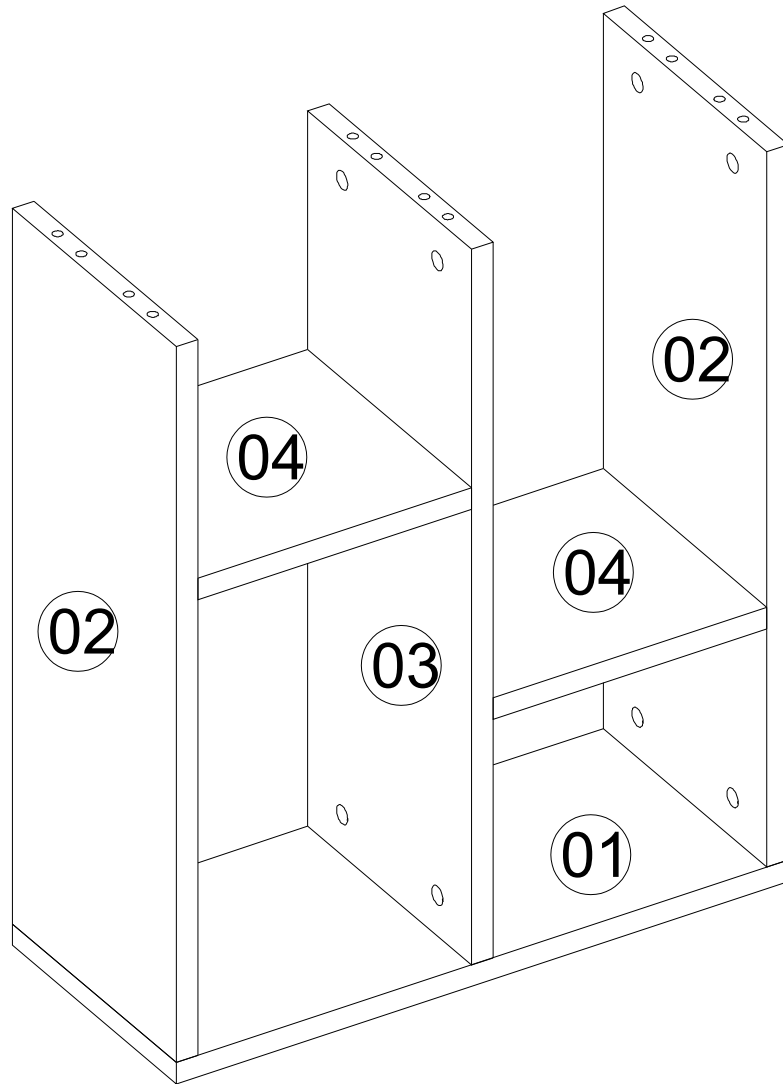

3

