

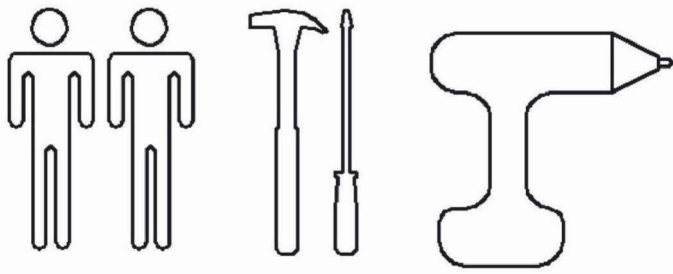













NOT :PLACE CROSS THE PORTABLE SHELVES



 MINIFIX SHAFT x 16	 MINIFIX HEAT x 16	 DOWEL: x 16	 PLASTIC PIN x 8
 SUPER CAMEL HINGE x 4	 HINGE x 2	 HOLDER x 3	 HOLDER SCREW x 6
 4x18 CHIPBOARD SCREW x 36	 PULLING SCREW x 4	 CORNER WEDGE x 12	 FOOT SEAL x 4
 H PROFILE x 1			

* FIX THE ACCESORIES AS SHOWN FOLLOW THE INSTALLATION SEQUENCE WHILE INSTALLING THE PRODUCT .

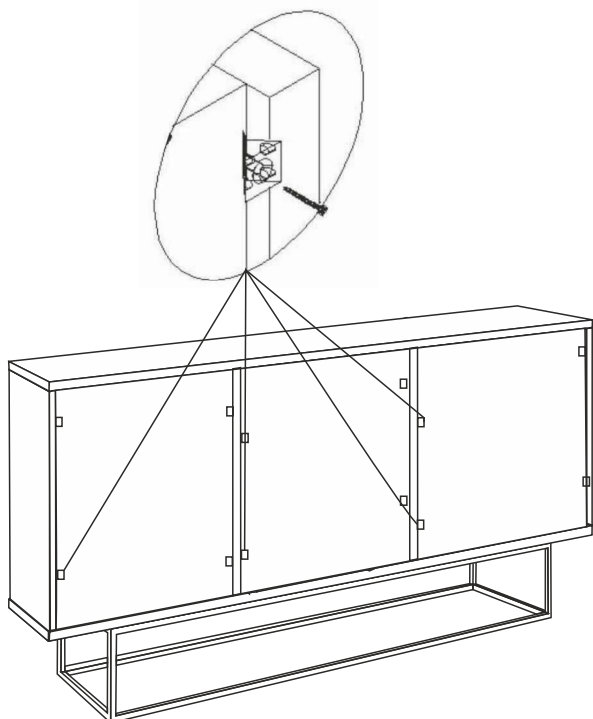
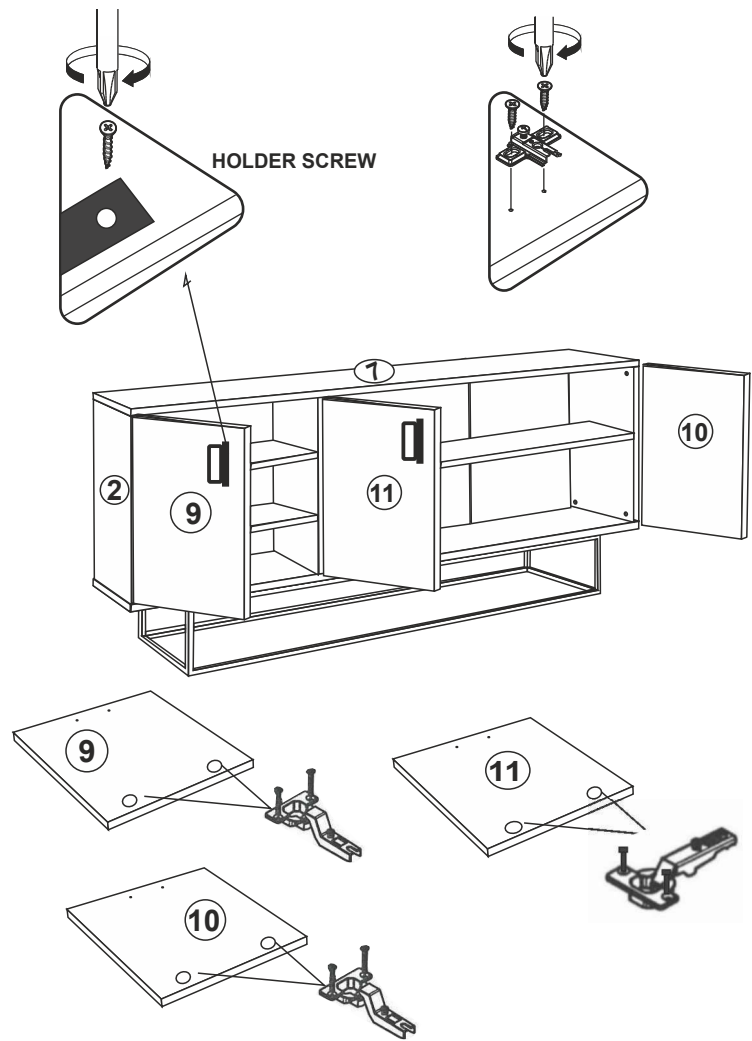

UV2520403 QUANTUM MARE (SIDE BOARD) ASSEMBLY GUIDE

