











Components:

1		2		3		4		5		6		7		8		9		10	
Inbus 1 pce	Fixing bolt M6x60 12 pcs	Fixing bolt M6x80 for ladder 4 pcs	Barrel nut 16 pcs	Wood dowels 35 pcs	Bolt (3,5 cm) 56 pcs	Confirmant 4 pcs	Bolt (to assembly drawer castors) 8 pcs	Drawer castors 4 pcs	Pin 6 pcs										

11	12
	
Connector	Drawer handle 2 pcs

Components

Bed:

1. A1 and A2- front panels– 2 pcs
2. B1 i B2- side bars – 2 pcs (left and right for lower bed)
3. B3 i B4- side bars – 2 pcs (left and right for upper bed)
4. Slats- 24/32 szt.\*

Drawer:

5. Drawer bottom – 1 pce
6. Drawer front – 1 pce
7. Drawer back – 1 pce
8. Drawer side panel- 2 pcs (left and right)
9. Drawer bottom support panel – 1 pce

\*depends on the bed size

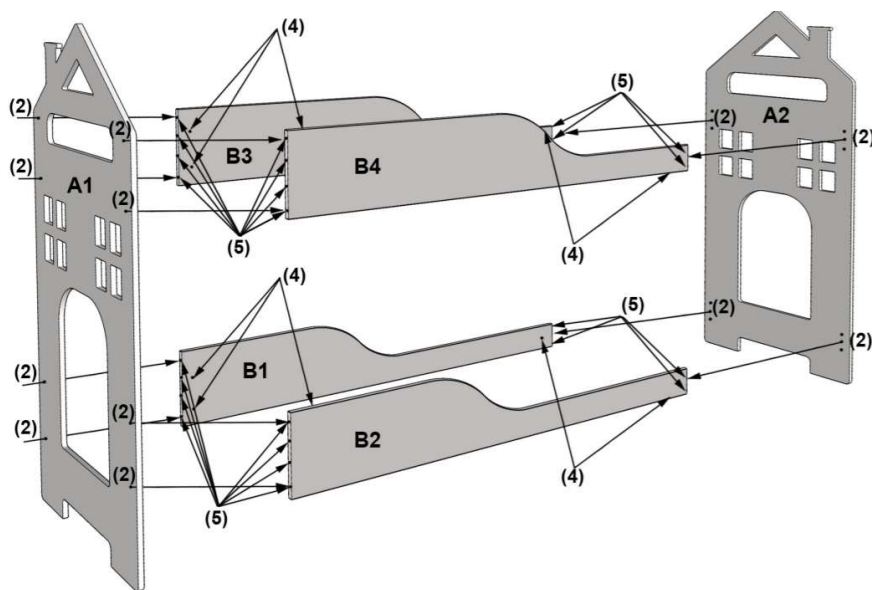

It is recommended that two people assemble the bed.

1. Start by constructing the slatted sides of your Bunk Bed and attach them to the starry front pieces of the bed. Place the wood dowels [5] in the side bars of the bed [B1, B2, B3 i B4 ], but leave the middle hole empty. Place 4 dowels into each side bars and 2 dowels on the opposite side. Place the barrel nuts [4] in the opening on the side of the barst connect them with front panels [A1 i A2]. Connect each side with the front panels of the bed using fixing bolt [2] and barrel nut (to each side bar use 2 barrel nuts on the outside and 1 barrel nut inside).

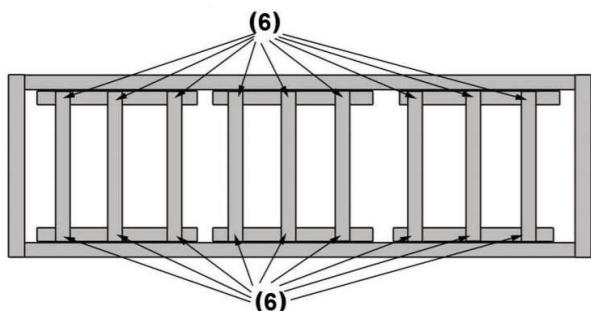

2. We already have the basic bed frame. If you have made sure that all the screws are properly screwed in, the next step is to install the rack slats. In the side bars [B1, B2, B3 i B4 ] there are slats adapted to the frame. Place the rack slats at a suitable distance from each other, and then fix them with bolts [6] and attached to the wang of the slats. The number of slats depends on their thickness and the size of the bed.

3. The bed is almost folded up – the last step is assembling the ladder. There are holes on the outside of the ladder (two at the top and two at the bottom). The screws [3] should be mounted to them so that they pass through the holes in the ladder and in the side bars. Protruding screws from the inside of the bed should be tightened with barrel nuts [4]. Make sure the ladder rests firmly against the bed.

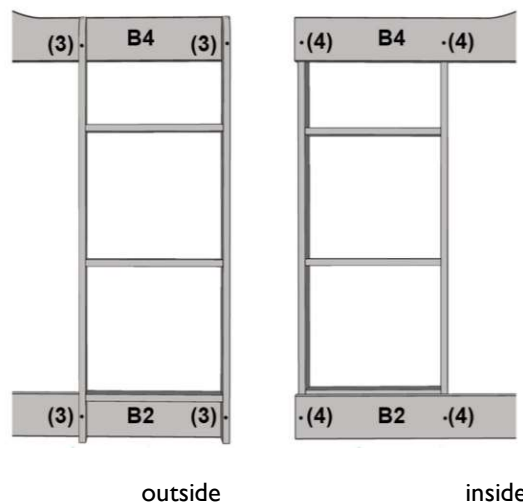

outside

inside

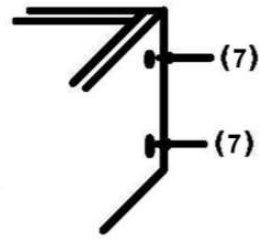
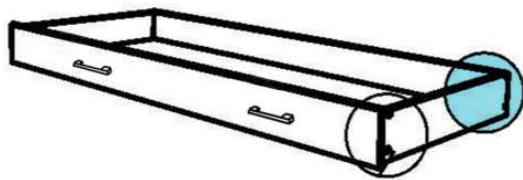

4. The last step is to assemble the drawer. Assemble the back of the drawer with its sides using confirmants [7]. Then insert the bottoms into the milled grooves inside the drawer.

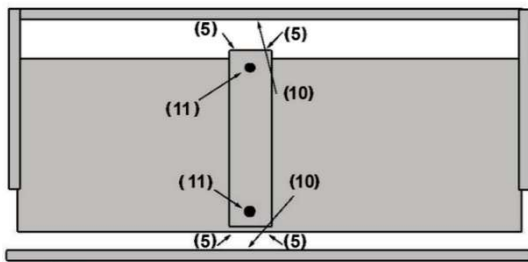

Install the drawer bottom support under the drawer by inserting the dowels [5] into its side openings, screw the pins [10] into the hole in the middle of the back and the front of the drawer, and the holes at the bottom of the bottom support - connectors [11], which we will tighten at the end after assembling the whole drawers.

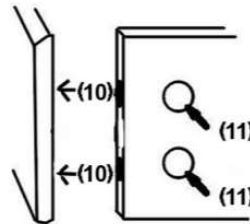
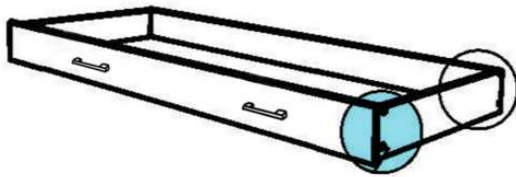

Finally, there is the drawer front, in which the pins [10] should be inserted from the inside. In the sides of the drawer, the connectors [11] should be placed, which must be tightened after joining the front with the sides. Screw the wheels to the edge of the drawer sides with screws [8] and the handles to the front.

Final remarks for the client:

1. The load capacity of the bed is 70 kg, but as manufacturers we guarantee that the parent can lie down with the child (load capacity up to 100/110 kg).
2. To avoid the risk of suffocation, dispose of plastic packaging or keep it out of the reach of children.
3. Before using the furniture, check the connections carefully and make sure that all screws are properly tightened as only this guarantees safe use.
4. We recommend using mattresses with dimensions of 160x80cm or 180x80 cm (depending on the size of the purchased bed). The length and width of the mattress must be such that the gap between the mattress and the sides and ends does not exceed 30 mm.
5. All mounting elements should always be properly tightened and regularly checked and tightened if necessary. Loose fasteners can catch your child's clothes or cut fingers or body. Spare parts can be obtained by contacting us.
6. The bed can be cleaned by wiping with a damp cloth and drying with a soft, clean cloth. Do not use abrasive cleaners, bleach, alcohol, or ammonia based cleaners.
7. Warning: Be aware of the risk of open fire and other strong heat sources such as electric or gas heaters etc. near the bed.
8. Warning: Under no circumstances should the bed be used if any part of it is damaged / torn, or in the absence of any element, contact the manufacturer and use only components approved by the manufacturer.
9. Warning: Do not leave anything in the bed that could cause the risk of suffocation or hanging the children, this also applies to placing the bed next to equipment, eg wires, cords, blinds and curtains.
10. Warning: The product should not come into contact with rubber locks which contain substances that have a negative effect on painted surfaces