

JULIETT 3S

VERSION NO.: 01-30.03.20



5min



x2

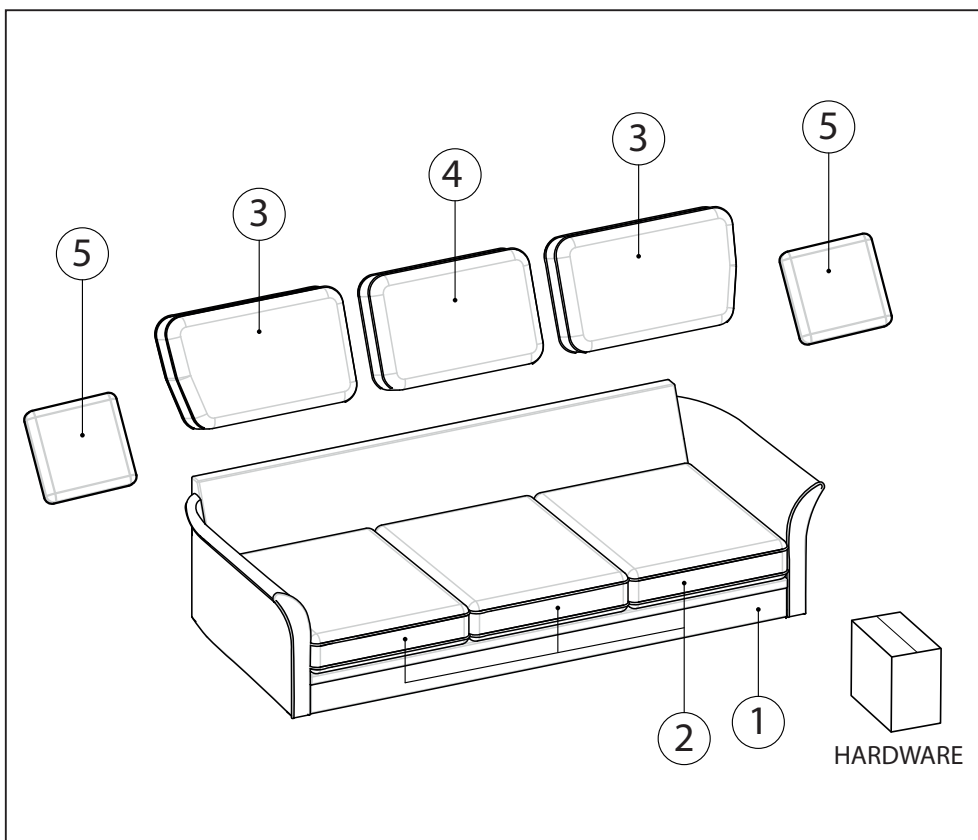



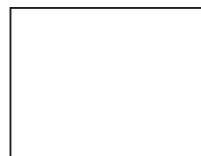
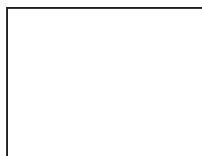
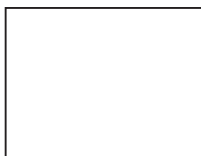
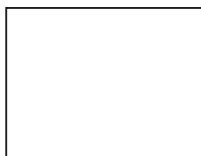
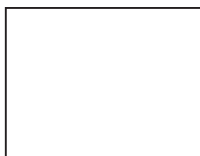
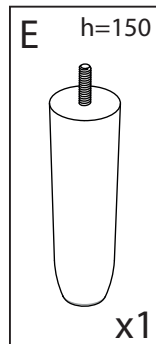
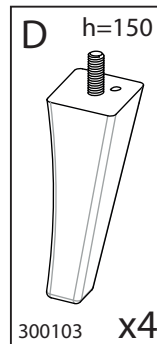
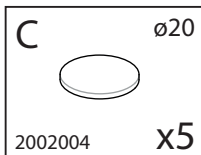
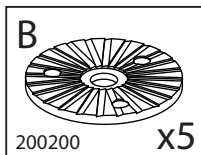
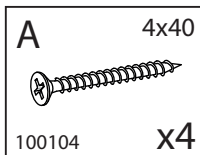
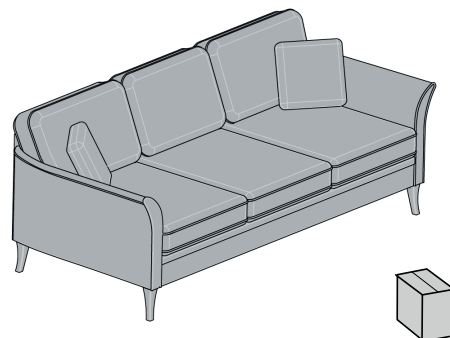

Pack 1 / 1

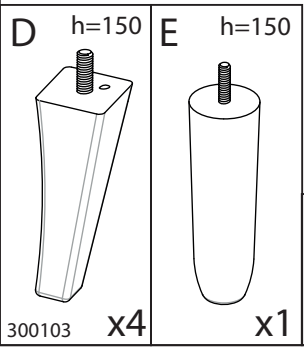
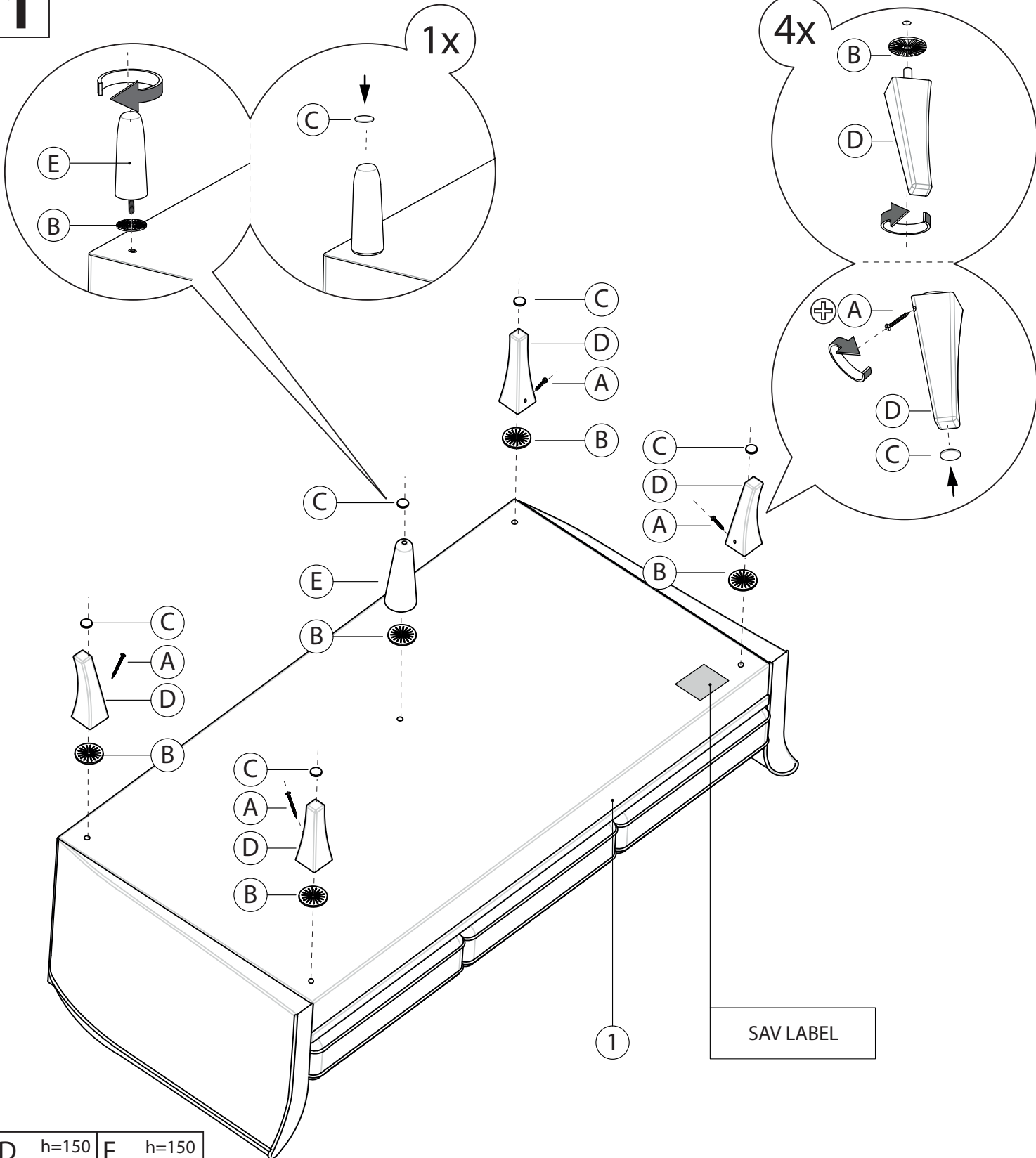

1



	A 4x40 	B 	C ø20 
	100104 x4	200200 x5	2002004 x5

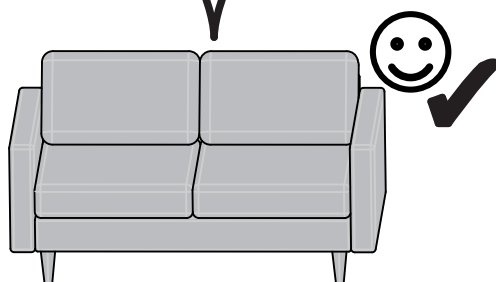
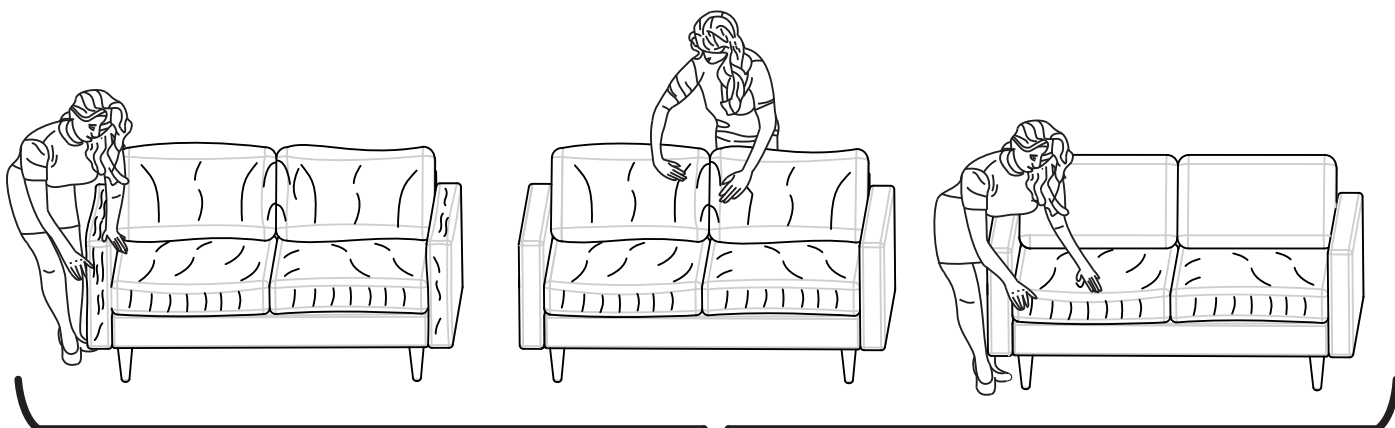
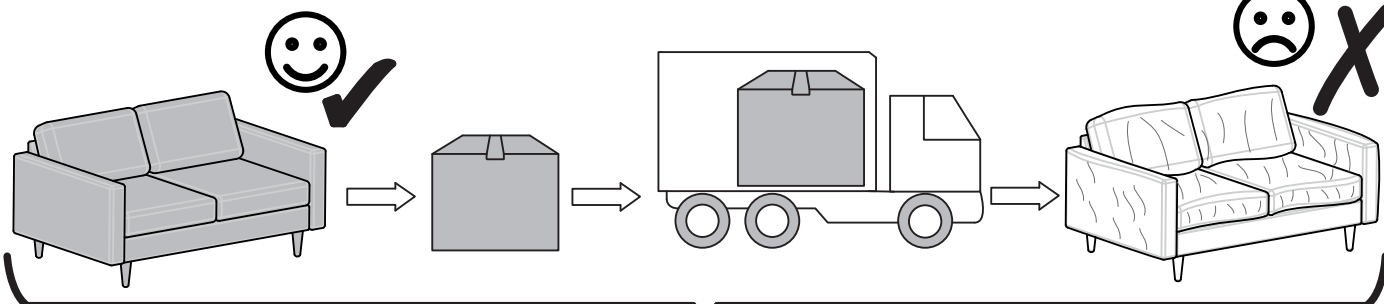
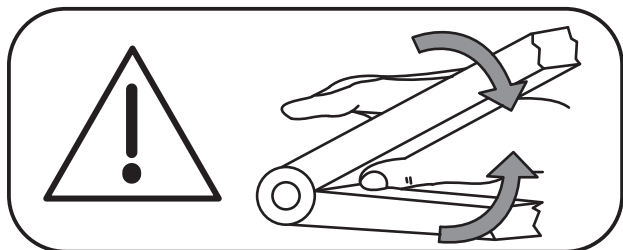
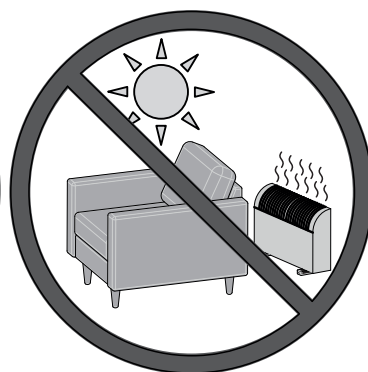

ENGLISH

ASSEMBLY ADVICE:

- CAREFULLY READ THE ASSEMBLY INSTRUCTION.
- IDENTIFY THE COMPONENTS OF THE FURNITURE.
- USE THE CORRECT TOOLS AND EQUIPMENT.
- USE THE REQUIRED TOOLS.
- CREATE AN ASSEMBLY ZONE.
- MAKE THE ASSEMBLY.

PAPER DECOR	LAMINATED SURFACES	LACQUERED SURFACES	WARMED WOOD	LEATHER TEXTILE
SOFT WATER (NEUTRAL SOAP)	●	●	●	●
WATER WITH DETERGENT	●	●	●	●
SPECIFIC SUPPLIER CLEANING				●

NEVER FORCE THE CONNECTIONS. RE-TIGHTEN THE SCREWS AFTER FEW DAYS. PLEASE RETAIN THE ALLELETT FOR FUTURE REFERENCE. THE AI CONTAINS INFORMATION WHEN CLAIMING FOR MESSING PARTS.

NEVER USE ABRASIVE PRODUCTS OR SOLVENTS. DO NOT APPLY EXCESSIVE PRESSURE WHEN USING THE DAMP CLOTH.

DEUTSCH - SCHWEIZ

MONTAGE ANLEITUNG:

- DIE MONTAGEANLEITUNG SORGFÄLTIG DURCHLESEN.
- VERWENDEN SIE DIE RICHTIGEN WERKZEUGE.
- DIE BESCHLÄGE ZUSAMMENLEGEN UND PRÜFEN.
- DAS MONTAGEZEUGE ZUREICHTLEGEN.
- ENEN MONTAGEBEREICH FREIHALTEN.
- DAS MONTAGEZEUGE ZUSAMMENBAUEN.

FEINPAPIER	OVERBLÄCHE LAMINAT	OVERBLÄCHE LACK	LACKIERTEM HOLZ	TEXTIL LEINER
WEICHES WASSER (NEUTRAL SEIFE)	●	●	●	●
WASSER MIT WÄSSERIGER REINIGER	●	●	●	●
SPEZIELLE REINIGER				●

MEINEN DIE VERBINDUNGEN ZU STARK ANZIEHEN. DIE SCHRAUBEN NACH EINIGER ZEIT DES GEBRAUCHS ERNEUT FESTZIEHEN. DIE AUFBAUANLEITUNG GIBT TEIL FEHLER, INFORMATIONEN. BEI ANSPRUCHEN WENIGSTENS MIT-TEIL MIT IHREM GESCHÄFT.

BRUCHEN SIE KEINE SCHREIBMATERIALIEN. NICHT MIT ÜBERMÄSSIGEM DRUCK VERFAHREN. BEI DER NUTZUNG DES FEUCHTEN TUCHES NICHT MIT ÜBERMÄSSIGEM DRUCK VERFAHREN.

FRANÇAIS - SUISSE

CONSEILS DE MONTAGE:

- BEN ETUDIER LA NOTICE DE MONTAGE.
- REPRENEZ LES VIS APRES QUELQUES TEMPS D'USAGE. GARDER VOTRE NOTICE DE MONTAGE. SI UNE PIÈCE VENAIT A MANQUER, ELLE SERAIT LE PLUS CLAIR MONTÉ. ELLE SERAIT LE PLUS CLAIR MAGASIN.
- N'UTILISER PAS DE PRODUITS ABRASIFS. POUDRE, LAINE D'ACIER, SOLVANTS. NE PAS MOILLER.

PAPIER DÉCOR	SURFACES STRATÉGIQUES	SURFACES LAQUÉES	BOS VENIS	TEXTILE CUIR
EAU SAVONNEUSE (SAVON NEUTRE)	●	●	●	●
EAU CHAUDE AVEC DÉTHERGENT	●	●	●	●
PRODUITS SPÉCIFIQUES				●

NIE WÄRMEN DIE VERBINDUNGEN ZU STARK ANZIEHEN. DIE SCHRAUBEN NACH EINIGER ZEIT DES GEBRAUCHS ERNEUT FESTZIEHEN. DIE AUFBAUANLEITUNG GIBT TEIL FEHLER, INFORMATIONEN. BEI ANSPRUCHEN WENIGSTENS MIT-TEIL MIT IHREM GESCHÄFT.

BRUCHEN SIE KEINE SCHREIBMATERIALIEN. NICHT MIT ÜBERMÄSSIGEM DRUCK VERFAHREN. BEI DER NUTZUNG DES FEUCHTEN TUCHES NICHT MIT ÜBERMÄSSIGEM DRUCK VERFAHREN.

POLSKI

WSKAZÓWKI MONTAŻOWE:

- WALEZY DOKŁADNIE PRZECZYTAĆ INSTRUKCJĘ MONTAŻU.
- WALEZY DOKŁADNIE PRZECZYTAĆ INSTRUKCJĘ MONTAŻU. DOKRĘCZAĆ ŚRUBKI PO WŁASNYM CZASIE.
- PODTRZYMAĆ ZACHOWAĆ ULOTKI AI NA PRZYSZŁOŚĆ. ZACHOWAĆ ULOTKI AI NA PRZYSZŁOŚĆ. ZACHOWAĆ ULOTKI AI NA PRZYSZŁOŚĆ.
- WYKORZYSTAĆ WŁASNE NARZĘDZIA.
- WYKORZYSTAĆ WŁASNE NARZĘDZIA.
- WYKORZYSTAĆ WŁASNE NARZĘDZIA.

PAPIER DEKORACYJNY	POWIERZCHNIE LAMINOWANE	POWIERZCHNIE LAKIEROWANE	DRZEWO LAKIEROWANE	SKÓRA TRAWIARNA
WODA Z MYDŁEM (NEUTRALNE MYDŁO)	●	●	●	●
WODA Z DETERGENTEM	●	●	●	●
WŁASNE NARZĘDZIA				●

NIE WYKORZYSTAĆ SIŁY PODCZAS MONTAŻU. DOKRĘCZAĆ ŚRUBKI PO WŁASNYM CZASIE. ZACHOWAĆ ULOTKI AI NA PRZYSZŁOŚĆ. ZACHOWAĆ ULOTKI AI NA PRZYSZŁOŚĆ. ZACHOWAĆ ULOTKI AI NA PRZYSZŁOŚĆ.

NIE WYKORZYSTAĆ SIŁY PODCZAS MONTAŻU. DOKRĘCZAĆ ŚRUBKI PO WŁASNYM CZASIE. ZACHOWAĆ ULOTKI AI NA PRZYSZŁOŚĆ. ZACHOWAĆ ULOTKI AI NA PRZYSZŁOŚĆ. ZACHOWAĆ ULOTKI AI NA PRZYSZŁOŚĆ.

PORTUGUÊS

CONSELHOS DE MONTAGEM:

- ESTUDE BEM AS INSTRUÇÕES DE MONTAGEM.
- RETIHA AS PEÇAS QUE CONSTITUÍREM O SEU MÓVEL.
- USE O TEMPO DEBIDAMENTE PARA AS NECESSÁRIAS. CONSERVE AS PEÇAS PARA A MONTAGEM.
- PREPARE UMA ÁREA PARA A MONTAGEM.
- INÍCIE A MONTAGEM.

PAPEL DECORATIVO	SUPERFÍCIES ESTRATIFICADAS	SUPERFÍCIES LACADAS	MADERA ENVERNIZADA	TÊXTEIS PELES
ÁGUA COM SABÃO (SABÃO NEUTRO)	●	●	●	●
ÁGUA COM DETERGENTE	●	●	●	●
INSTRUMENTOS ESPECÍFICOS DE FABRICANTE				●

NUNCA FORÇAR OS ENCAIXES. REPARAR OS PARAFUSOS APÓS UM TEMPO DE UTILIZAÇÃO. GUARDAR AS INSTRUÇÕES DE MONTAGEM. CASO FALTE ALGUMA PEÇA, O MAIS ADEQUADO É CONTACTAR O REPRESENTADOR.

NUNCA UTILIZAR PRODUTOS ABRASIVOS. SAPONIFICADOS, LÁ DE AÇO, SOLVENTES. NÃO MOLHAR.

ITALIANO - SVIZZERA

CONSIGLI DI MONTAGGIO:

- STUDIARE BENE LE ISTRUZIONI DI MONTAGGIO.
- PREPARARE UN'AREA PER IL MONTAGGIO.
- PREPARARE UN'AREA PER IL MONTAGGIO.
- PREPARARE UN'AREA PER IL MONTAGGIO.
- PREPARARE UN'AREA PER IL MONTAGGIO.
- PREPARARE UN'AREA PER IL MONTAGGIO.

ACQUA CON SAPONE (SAPONE NEUTRO)	●	●	●	●
ACQUA CON DETERGENTE SANITARIO	●	●	●	●
STRUMENTI SPECIFICI DI FABBRICANTE				●

NON FORZARE MAI GLI ASSEMBLAGGI. RISTRINGERE LE VITI DOPO UN PERIODO DI USO. CONSERVARE QUESTE ISTRUZIONI DI MONTAGGIO. SE UN PEZZO VENISSE A MANCARE SAREBBE IL MIGLIORE MEZZO DI COMUNICAZIONE CON IL RICHIEDITORE.

NON UTILIZZARE MAI PRODOTTI ABRASIVI. POLVERE, LANA DI ACCIAIO, SOLVENTI. NON BAGNARE.

ESPAÑOL

CONSEJOS PARA EL MONTAJE:

- ESTUDIE ATENTAMENTE EL MANUAL DE MONTAJE.
- LOCAR LAS PIEZAS QUE CONSTITUYEN SU MUEBLE.
- PREPARAR UN ESPACIO PARA EL MONTAJE.
- PREPARAR UN ESPACIO PARA EL MONTAJE.
- PREPARAR UN ESPACIO PARA EL MONTAJE.
- PREPARAR UN ESPACIO PARA EL MONTAJE.

AGUA Y JABÓN (JABÓN NEUTRO)	●	●	●	●
AGUA CON DETERGENTE SANITARIO	●	●	●	●
ESPECIFICOS DE FABRICANTE				●

NO FUERCE NUNCA EN LAS UNIONES. APRIE LOS TORNILLOS DESPUÉS DE CIERTO TIEMPO DE UTILIZACIÓN. CONSERVE SU MANUAL DE MONTAJE. SI FALTARA UNA PIEZA, SERIA LA MANERA MAS FACIL DE COMUNICAR CON LA TIENDA.

NO USE NUNCA PRODUCTOS ABRASIVOS TALES COMO: POLVO DE LIMPIAR, LANA DE ACERO, SOLVENTES. NO MOJAR.

HRVATSKA

UPUTE ZA MONTAŽU:

- PAŽLJIVO PROČITAJTE UPUTE ZA MONTAŽU.
- PRIPRIJETE SVE DIOVE I NAMJEŠTAJA.
- PRIPRIJETE I PROVERITE OKOJE ZA MONTAŽU.
- PRIPRIJETE POTREBNA ALAT.
- PRIPRIJETE PROSTOR ZA MONTAŽU.
- POČINITE MONTIRATI.
- SACUVAJTE OVE UPUTE.
- PROZIVODIJE JE NAMENJEN ISKLJUČIVO ZA KUĆNO UPOTREBU.

PAPIR	LAMINAT	LAK	DRVO	TEKSTIL KOŽA
OPPIVA SAPUNA	●	●	●	●
OPPIVA SAPUNA	●	●	●	●
NAMJEŠTAKSKE SREDSTVA				●

NEKORISTITE SILOU PRILIKOM SKLAPANJA. NAKON NEKOG VREMENA, PONOVO POKRETNOSTI VINE ČUVATI UPUTE ZA MONTAŽU I SAČUVATI NEODSTATAK NEKOG RJEŠENJA. NEKORISTITE PROSTOR ZA MONTAŽU PRILIKOM MONTIRANJA.

ZABRANJENO JE UPOTREBU KEMIKALIJA I BLO KAKOVIH POMOĆNIH SREDSTAVA ZA RJEŠAVANJE. NEKORISTITE SREDSTVA ZA ČIŠĆENJE I ČEŠĆE VINE NE MOŽRA.

TÜRKÇE

BAKIM TALİMATLARI:

- MONTAJI DİKKATLE OKUYUNUZ.
- MONTAJI ÖZEL ALANLARDA YAPINIZ.
- MONTAJI ÖZEL ALANLARDA YAPINIZ.
- MONTAJI ÖZEL ALANLARDA YAPINIZ.
- MONTAJI ÖZEL ALANLARDA YAPINIZ.
- MONTAJI ÖZEL ALANLARDA YAPINIZ.

SUS KAGIDI	KATMAN YIZEY	LAK YIZEY	LAK YIZEY	TEKSTİL DERİ
SABUNLU SU (NÖTR SABUN)	●	●	●	●
DETERJAN KATMANLARI	●	●	●	●
ÖZEL ALANLARDA YAPINIZ				●

MONTAJI DİKKATLE OKUYUNUZ. MONTAJI ÖZEL ALANLARDA YAPINIZ. MONTAJI ÖZEL ALANLARDA YAPINIZ. MONTAJI ÖZEL ALANLARDA YAPINIZ. MONTAJI ÖZEL ALANLARDA YAPINIZ. MONTAJI ÖZEL ALANLARDA YAPINIZ.

SRBIJA

UPUTE ZA MONTAŽU:

- PAŽLJIVO PROČITAJTE UPUTE ZA MONTAŽU.
- PRIPRIJETE SVE DIOVE I NAMJEŠTAJE.
- PRIPRIJETE I PROVERITE OKOJE ZA MONTAŽU.
- PRIPRIJETE POTREBNA ALAT.
- PRIPRIJETE PROSTOR ZA MONTAŽU.
- POČINITE MONTIRATI.
- SACUVAJTE OVE UPUTE.
- PROZIVODIJE JE NAMENJEN ISKLJUČIVO ZA KUĆNO UPOTREBU.

PAPIR	LAMINAT	LAK	DRVO	TEKSTIL KOŽA
OPPIVA SAPUNA	●	●	●	●
OPPIVA SAPUNA	●	●	●	●
NAMJEŠTAKSKE SREDSTVA				●

NEKORISTITE SILOU PRILIKOM SKLAPANJA. NAKON NEKOG VREMENA, PONOVO POKRETNOSTI VINE ČUVATI UPUTE ZA MONTAŽU I SAČUVATI NEODSTATAK NEKOG RJEŠENJA. NEKORISTITE PROSTOR ZA MONTAŽU PRILIKOM MONTIRANJA.

ZABRANJENO UPOTREBU KEMIKALIJA I BLO KAKOVIH POMOĆNIH SREDSTAVA ZA RJEŠAVANJE. NEKORISTITE SREDSTVA ZA ČIŠĆENJE I ČEŠĆE VINE NE MOŽRA.