

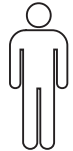





SVEA 2S

VERSION NO.: 02-17.07.20

 5min	 x2	 	
---	---	--	---

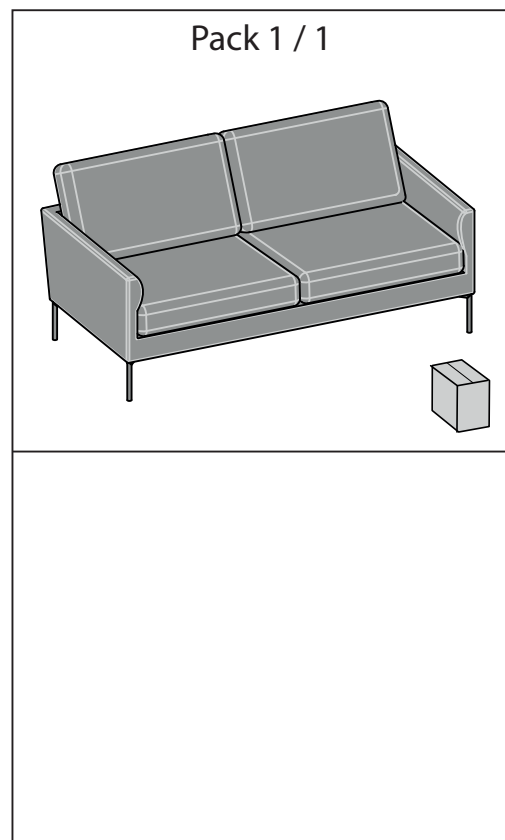
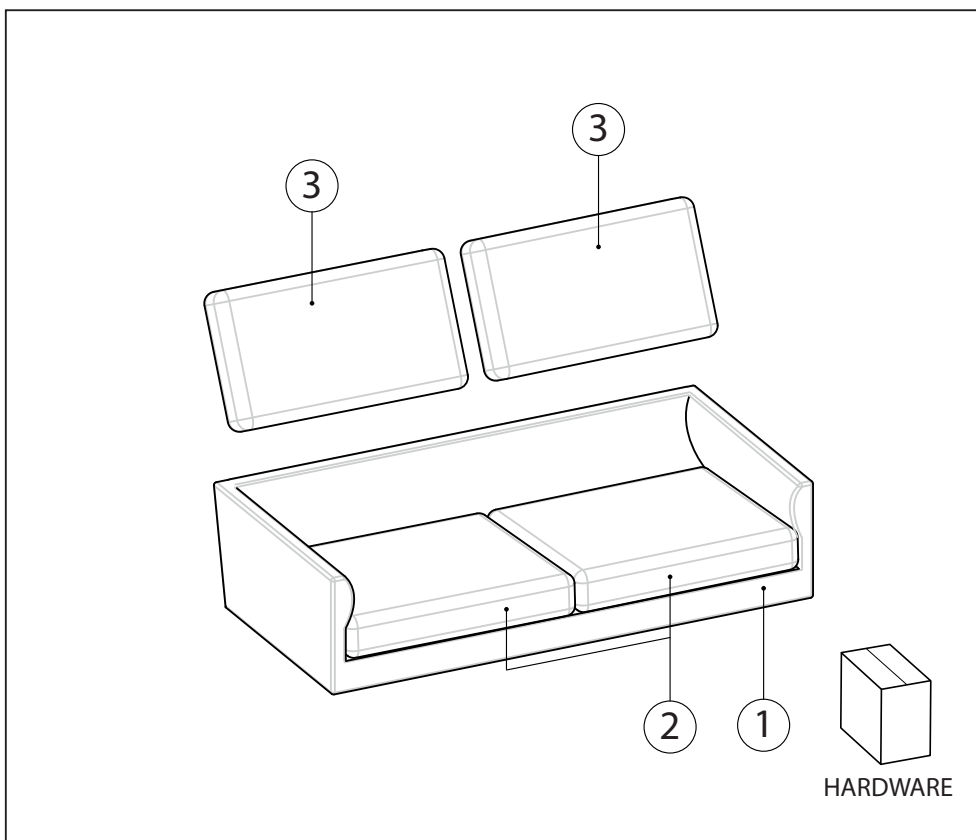

A M6x25

 100100 x12

B ø20

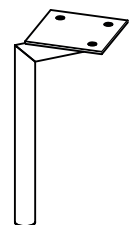
 200204 x4

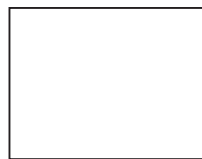
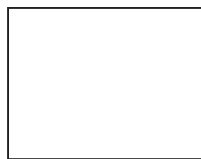
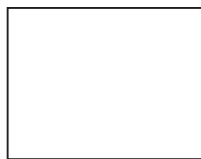
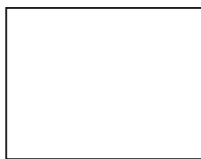
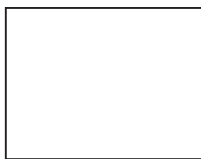
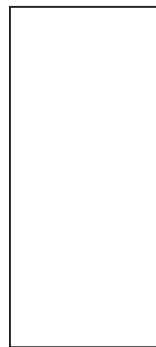

C h=195

 300168 x4

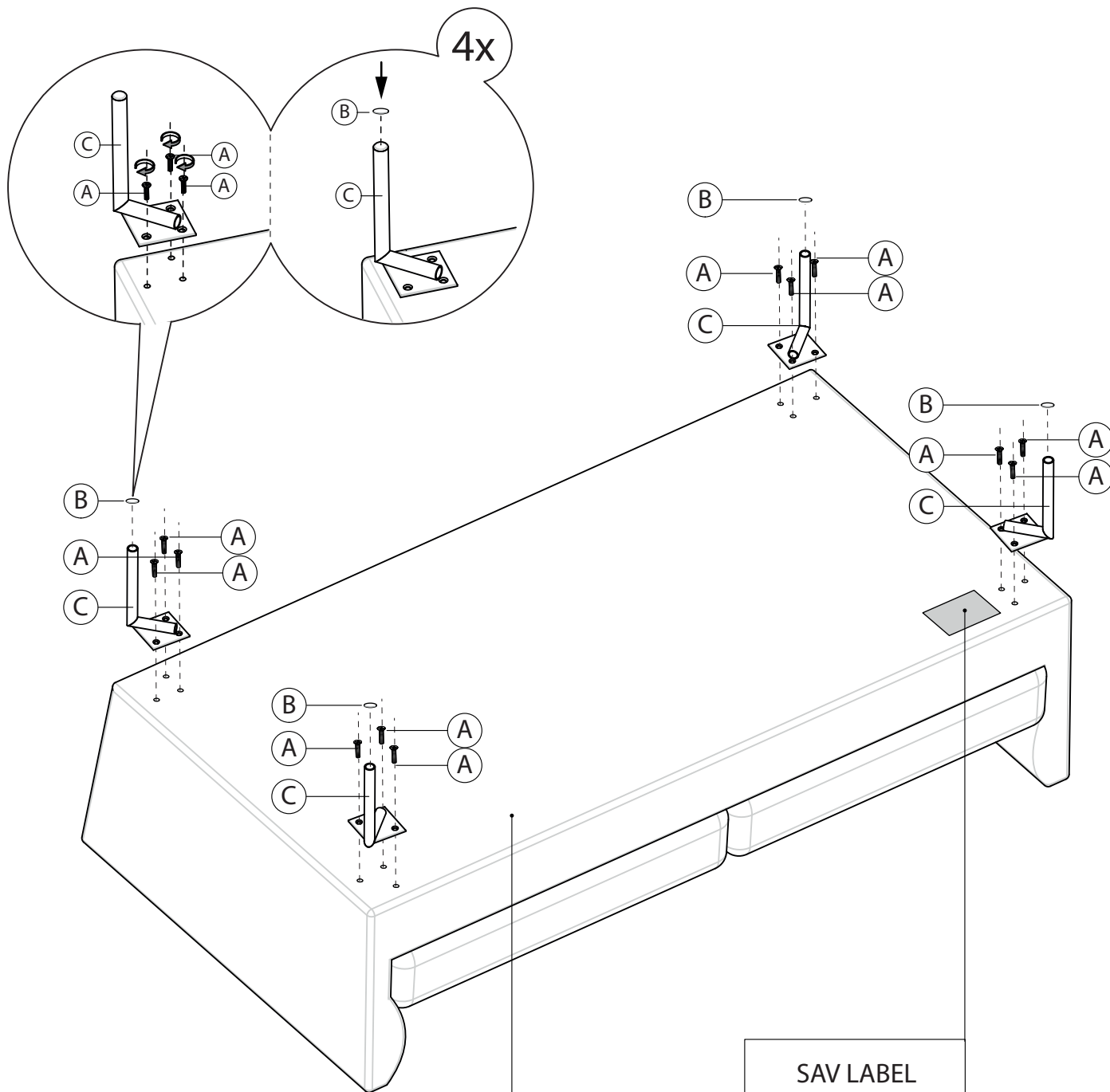

1

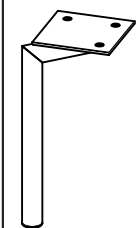

C h=195



300168 x4



A M6x25



100100 x12

B ø20



200204 x4

1

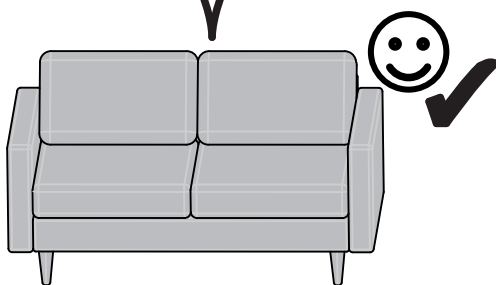
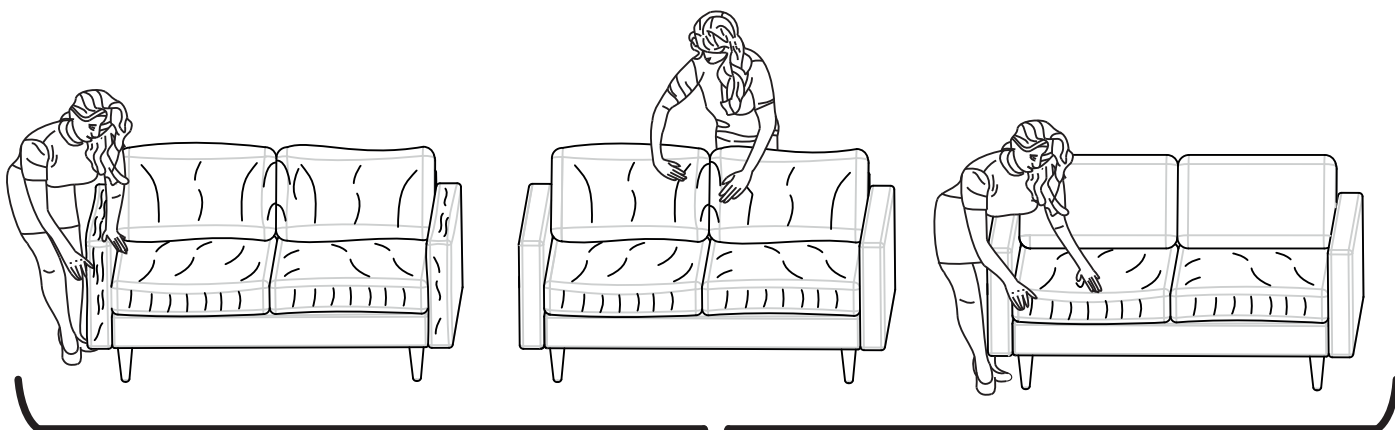
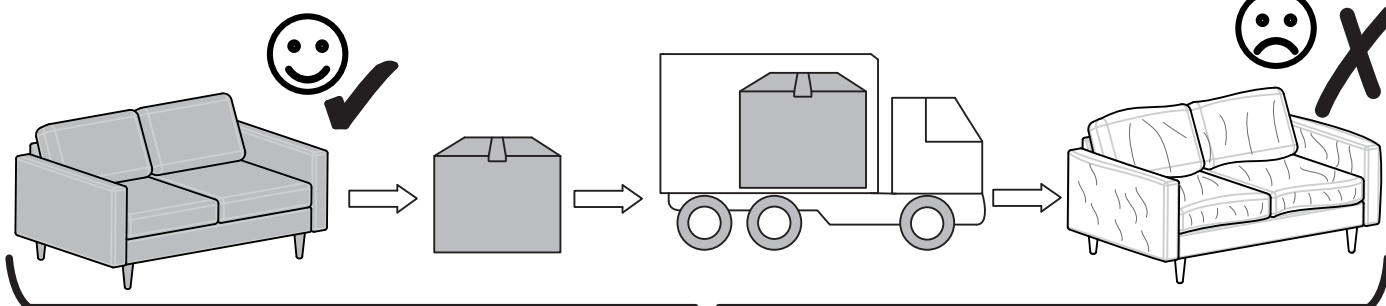
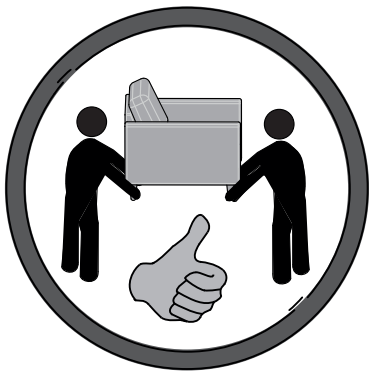
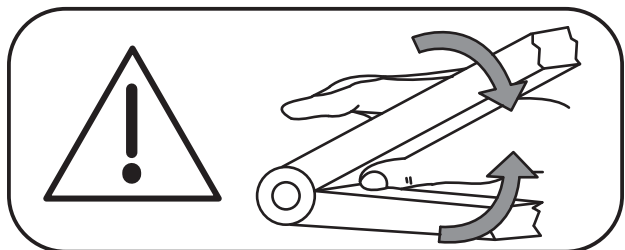
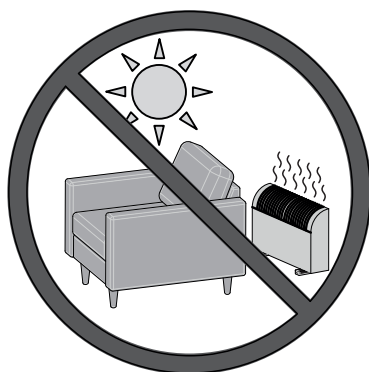

ENGLISH

ASSEMBLY ADVICE:

- CAREFULLY READ THE ASSEMBLY INSTRUCTION.
- IDENTIFY THE COMPONENTS OF THE FURNITURE.
- USE THE CORRECT TOOLS AND EQUIPMENT.
- USE THE REQUIRED TOOLS.
- CREATE AN ASSEMBLY ZONE.
- MAKE THE ASSEMBLY.

PAPER DECOR	LAMINATED SURFACES	LACQUERED SURFACES	WARMED WOOD	LEATHER TEXTILE
SOFT WATER (NEUTRAL SOAP)	●	●	●	●
WATER WITH DETERGENT	●	●	●	●
SPECIFIC SUPPLIER CLEANING				●

NEVER FORCE THE CONNECTIONS. RE-TIGHTEN THE SCREWS AFTER FEW DAYS. PLEASE RETAIN THE ALLELEIET FOR FUTURE REFERENCE. THE AI CONTAINS INFORMATION WHEN CLAIMING FOR MESSING PARTS.

NEVER USE ABRASIVE PRODUCTS OR SOLVENTS. DO NOT APPLY EXCESSIVE PRESSURE WHEN USING THE DAMP CLOTH.

DEUTSCH - SCHWEIZ

MONTAGE ANLEITUNG:

- DIE MONTAGEANLEITUNG SORGFÄLTIG DURCHLESEN.
- VERWENDEN SIE DIE RICHTIGEN WERKZEUGE.
- DIE BESCHLÄGE ZUSAMMENLEGEN UND PRÜFEN.
- DAS MONTAGEGEBIEH ZUREICHTLEGEN.
- DEN MONTAGEBEREICH FREIHALTEN.
- DAS MONTAGESTÜCK ZUSAMMENBAUEN.

FEINPAPIER	ÜBERFLÄCHE LACK	LACKIERTEM HOLZ	WÄRMED LEINER	LEINER
WEICHES WASSER (NEUTRAL SEIFE)	●	●	●	●
WASSER MIT WÄSSERIGER REINIGER	●	●	●	●
SPEZIELLE REINIGER				●

MEINEN DIE VERBINDUNGEN ZU STARK ANZIEHEN. DIE SCHRAUBEN NACH EINIGER ZEIT DES GEBRAUCHS ERNEUT FESTZIEHEN. BEHALTEN SIE DIE ALLELEIET FÜR ZUKÜNFTIGE REFERENZ. DIE AI ENTHÄLT INFORMATIONEN BEI ANSPRUCH.

VERWENDEN SIE KEINE SCHLEIFMITTEL WIE PULVER, STAHLWOLLE, LÖSUNGSMITTEL. KEIN WASSER VERWENDEN.

FRANÇAIS - SUISSE

CONSEILS DE MONTAGE:

- BEN ETUDIER LA NOTICE DE MONTAGE.
- REPRENEZ LES VIS APRES QUELQUES TEMPS D'USAGE. GARDER VOTRE NOTICE DE MONTAGE. SI UNE PIÈCE VENAIT À MANQUER, ELLE SERAIT LE PLUS CLAIR MONTÉ DE COMMUNIQUER AVEC VOTRE MAGASIN.
- N'AMBIEN UTILISER DE PRODUITS ABRASIFS: POUDRE, LANE D'ACIER, SOLVANTS. NE PAS MOILLER.

PAPIER DÉCOR	SURFACES STRATÉGIQUES	SURFACES LAQUÉES	BOS VENIS	TEXTILE CUIR
EAU SAVONNEUSE (SAVON NEUTRE)	●	●	●	●
EAU AVEC DÉTERGENT LIQUIDE	●	●	●	●
PRODUIT DE NETTOYAGE SPÉCIFIQUE				●

NIE UŻYWAJ NADMIERNIE SIŁY PODCZAS MONTAŻU. DOKRĘCJĘ ŚRUBY PO WŁIKU DNIAŁACH. PROSZĘ ZACHOWAĆ ULOTKI AI NA PRZYSZŁOŚĆ. JEŚLI BRZAKI, NIE MAJĄC POTRZEBY DO ZŁOŻENIA BRUKUJĄCYCH CZĘŚCI.

NIGDY NIE UŻYWAJ PRODUKTÓW ŚCIERNYCH LUB ZAMIERAJĄCYCH ROZPUŚCZALNIKI NIE WALEŻY NADMIERNIE POCIERAĆ POWIERZCHNI MEBLA. PODCZAS UŻYWANIA, ŚCIERNI.

POLSKI

WSKAZÓWKI MONTAŻOWE:

- WALEŻY DOKŁADNIE PRZECZYTAĆ INSTRUKCJĘ MONTAŻU.
- DOKRĘCJAĆ ŚRUBY PO WŁIKU DNIAŁACH. PROSZĘ ZACHOWAĆ ULOTKI AI NA PRZYSZŁOŚĆ. JEŚLI BRZAKI, NIE MAJĄC POTRZEBY DO ZŁOŻENIA BRUKUJĄCYCH CZĘŚCI.
- NIGDY NIE UŻYWAJ PRODUKTÓW ŚCIERNYCH LUB ZAMIERAJĄCYCH ROZPUŚCZALNIKI NIE WALEŻY NADMIERNIE POCIERAĆ POWIERZCHNI MEBLA. PODCZAS UŻYWANIA, ŚCIERNI.

PAPIER DEKORACYJNY	POWIERZCHNIE STRATYFIKOWANE	POWIERZCHNIE LAKOWANE	DRZEWO LAKOWANE	SKÓRA TRAWIARNA
WODA Z MYDŁEM (MYDŁO NEUTRALNE)	●	●	●	●
WODA Z DETERGENTEM	●	●	●	●
WYKONCZONY SPECJALNY CZYSZCZĄCY PRODUKT				●

NIE UŻYWAJ NADMIERNIE SIŁY PODCZAS MONTAŻU. DOKRĘCJĘ ŚRUBY PO WŁIKU DNIAŁACH. PROSZĘ ZACHOWAĆ ULOTKI AI NA PRZYSZŁOŚĆ. JEŚLI BRZAKI, NIE MAJĄC POTRZEBY DO ZŁOŻENIA BRUKUJĄCYCH CZĘŚCI.

NIGDY NIE UŻYWAJ PRODUKTÓW ŚCIERNYCH LUB ZAMIERAJĄCYCH ROZPUŚCZALNIKI NIE WALEŻY NADMIERNIE POCIERAĆ POWIERZCHNI MEBLA. PODCZAS UŻYWANIA, ŚCIERNI.

PORTUGUÊS

CONSELHOS DE MONTAGEM:

- ESTUDE BEM AS INSTRUÇÕES DE MONTAGEM.
- RETIJA AS PEÇAS QUE CONSTITUÍREM O SEU MÓVEL.
- RETIJA AS PEÇAS QUE CONSTITUÍREM O SEU MÓVEL. CONSERVE AS PEÇAS PARA A MONTAGEM.
- PREPARE UMA ÁREA PARA A MONTAGEM.
- INÍCIE A MONTAGEM.

ACABAMENTO EM PAPEL	SUPERFÍCIES ESTRATIFICADAS	SUPERFÍCIES LACADAS	MADERA ENVERNIZADA	TEJIDOS PELES
ÁGUA COM SABÃO (SABÃO NEUTRO)	●	●	●	●
ÁGUA COM DETERGENTE	●	●	●	●
INSTRUÇÕES ESPECÍFICAS DO FABRICANTE				●

NUNCA FORÇAR OS ENCAIXES. REPARAR OS PARAFUSOS APÓS UM TEMPO DE UTILIZAÇÃO. GUARDAR AS INSTRUÇÕES DE MONTAGEM. CASO FALTE ALGUMA PEÇA, O MAIS ACONSELHÁVEL É CONTACTAR O REVENDEDOR.

NUNCA UTILIZAR PRODUTOS ABRASIVOS: SAPONICIDOS, LÁ DE AÇO, SOLVENTES. NÃO MOLHAR.

ITALIANO - SVIZZERA

CONSIGLI DI MONTAGGIO:

- STUDIARE BENE LE ISTRUZIONI DI MONTAGGIO.
- PREPARARE UN'AREA PER IL MONTAGGIO.
- PREPARARE UNA ZONA DI MONTAGGIO.
- PROCEDERE AL MONTAGGIO.

ACQUA CON SAPONE (SAPONE NEUTRO)	SUPERFICIE STRATIFICATE	SUPERFICIE LACATE	LACCHATE EGOVERNIZATE	TESSILI CUOIO
ACQUA CON DETERGENTE SANITARIO	●	●	●	●
MANUTENZIONE SPECIFICA PRODUTTORE				●

NON FORZARE MAI GLI ASSEMBLAGGI. RISTRINGERE LE VITI DOPO UN PERIODO DI USO. CONSERVARE QUESTE ISTRUZIONI DI MONTAGGIO. SE UN PEZZO VENISSE A MANCARE SAREBBE IL MIGLIORE MEZZO DI COMUNICAZIONE CON IL RICHIEDITORE.

NON UTILIZZARE MAI PRODOTTI ABRASIVI: POLVERE, LANA DI ACCIAIO, SOLVENTI. NON BAGNARE.

ESPAÑOL

CONSEJOS PARA EL MONTAJE:

- ESTUDIE ATENTAMENTE EL MANUAL DE MONTAJE.
- LOCATE LAS PIEZAS QUE CONSTITUYEN SU MUEBLE.
- PREPARE UN ESPACIO PARA EL MONTAJE.
- PREPARE UNA ZONA DE MONTAJE.
- REALICE EL MONTAJE.

AGUA Y ABRON (ABON NEUTRO)	PAPIER DE DECORACION	SUPERFICIE ESTRATIFICADAS	SUPERFICIE AMARQUEADAS	MADERA BARNIZADA	TEJIL CUIRO
AGUA CON DETERGENTE	●	●	●	●	●
MANTENIMIENTO ESPECIFICO DEL FABRICANTE					●

NO FUERCE NUNCA EN LAS UNIONES. APRIE LOS TORNILLOS DESPUES DE CIERTO TIEMPO DE UTILIZACION. CONSERVE SU MANUAL DE MONTAJE. SI FALTARA UNA PIEZA, SERA LA MANERA MAS FACIL DE COMUNICAR CON LA TIENDA.

NO USE NUNCA PRODUCTOS ABRASIVOS TALES COMO: POLVO DE LIMPIAR, LANA DE ACERO, SOLVENTES. NO MOJAR.

HRVATSKA

UPUTE ZA MONTAŽU:

- PAŽLJIVO PROČITAJTE UPUTE ZA MONTAŽU.
- PRIPRIJETE SVE DIOVE I NAMJEŠTALA.
- PRIPRIJETE I PROVERTE OKOJE ZA MONTAŽU.
- PRIPRIJETE POTREBNA ALAT.
- PRIPRIJETE PROSTOR ZA MONTAŽU.
- POČINITE MONTIRATI.
- SACUVAJTE OVE UPUTE.
- PROIZVOĐ JE NAMENJEN ISKLJUČIVO ZA KUĆNO UPOTREBU.

OPINA SAPUNA	PAPIR	LAK	DRVO	TEKSTIL KOŽA
OPINA SAPUNA	●	●	●	●
NAMJEŠTAKA SREDSTVA				●

NEKOLIKO UPOTREBUJAVATI SILE PRILIKOM SLAGANJA. NAKON NEKOG VREMENA PONOVNO PREGNITE VINE ČUVAJTE UPUTE ZA MONTAŽU I SUCUJ NEODSTATAK NEKOG DIELA. Ukoliko JE NEKAKO TEŠKO MONTIRATI, PRONAĐI MJEŠTO.

ZABRANJENO JE UPOTREBA KEMIKALIJA Ili BILIKO KAKOVIH SREDSTAVA ZA ČIŠĆENJE Ili RIBANJE. JAKOVI SREDSTAVA ZA ČIŠĆENJE Ili CEĐIONE VINE NE MOŽRA.

TÜRKÇE

BAKIM TALIMATLARI:

- MONTAJI DİKKATLİCE OKUYUNUZ.
- MONTAJI ÖZEL ALANLARDA YAPINIZ.
- MONTAJI ÖZEL ALANLARDA YAPINIZ.
- MONTAJI ÖZEL ALANLARDA YAPINIZ.
- MONTAJI ÖZEL ALANLARDA YAPINIZ.
- MONTAJI ÖZEL ALANLARDA YAPINIZ.
- MONTAJI ÖZEL ALANLARDA YAPINIZ.
- MONTAJI ÖZEL ALANLARDA YAPINIZ.

SABUNLU SU (NÖTR SABUN)	SUS KAGIDINI	KATMAN YIZEY	LAKE YIZEY	TEKSTIL DERI
DETERJAN KATMANLARI	●	●	●	●
ÖZEL ALANLARDA YAPINIZ				●

MONTAJI DİKKATLİCE OKUYUNUZ. MONTAJI ÖZEL ALANLARDA YAPINIZ. MONTAJI ÖZEL ALANLARDA YAPINIZ. MONTAJI ÖZEL ALANLARDA YAPINIZ. MONTAJI ÖZEL ALANLARDA YAPINIZ. MONTAJI ÖZEL ALANLARDA YAPINIZ. MONTAJI ÖZEL ALANLARDA YAPINIZ. MONTAJI ÖZEL ALANLARDA YAPINIZ.

SRBIJA

UPUTE ZA MONTAŽU:

- PAŽLJIVO PROČITAJTE UPUTE ZA MONTAŽU.
- PRIPRIJETE SVE DIOVE I NAMJEŠTALA.
- PRIPRIJETE I PROVERTE OKOJE ZA MONTAŽU.
- PRIPRIJETE POTREBNA ALAT.
- PRIPRIJETE PROSTOR ZA MONTAŽU.
- POČINITE MONTIRATI.
- SACUVAJTE OVE UPUTE.
- PROIZVOĐ JE NAMENJEN ISKLJUČIVO ZA KUĆNO UPOTREBU.

OPINA SAPUNA	PAPIR	LAK	DRVO	TEKSTIL KOŽA
OPINA SAPUNA	●	●	●	●
NAMJEŠTAKA SREDSTVA				●

NEKOLIKO UPOTREBUJAVATI SILE PRILIKOM SLAGANJA. NAKON NEKOG VREMENA PONOVNO PREGNITE VINE ČUVAJTE UPUTE ZA MONTAŽU I SUCUJ NEODSTATAK NEKOG DIELA. Ukoliko JE NEKAKO TEŠKO MONTIRATI, PRONAĐI MJEŠTO.

ZABRANJENO UPOTREBA KEMIKALIJA Ili BILIKO KAKOVIH SREDSTAVA ZA ČIŠĆENJE Ili RIBANJE. JAKOVI SREDSTAVA ZA ČIŠĆENJE Ili CEĐIONE VINE NE MOŽRA.