

SVEA 3S

VERSION NO.: 02-17.06.20



5min



x2

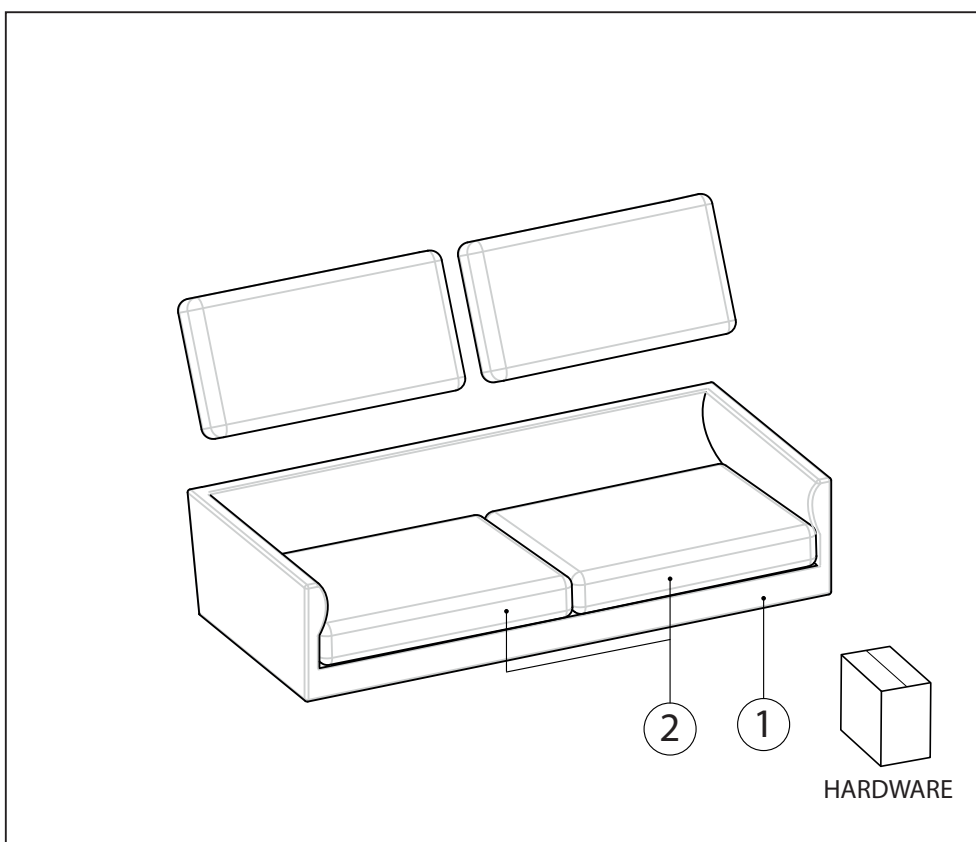

Pack 1 / 1

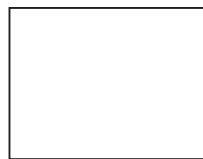
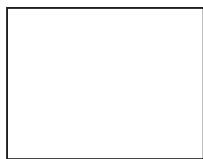
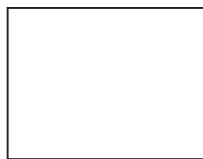
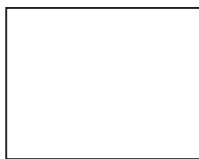
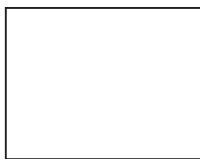
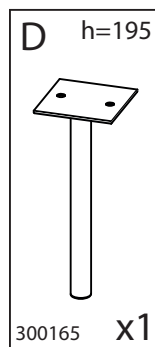
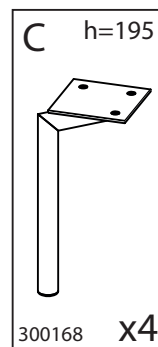
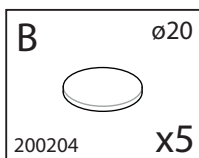
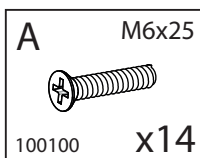
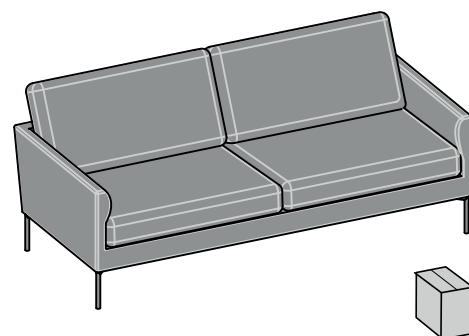

1

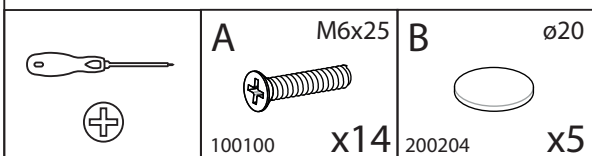
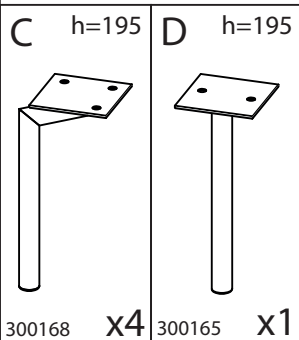
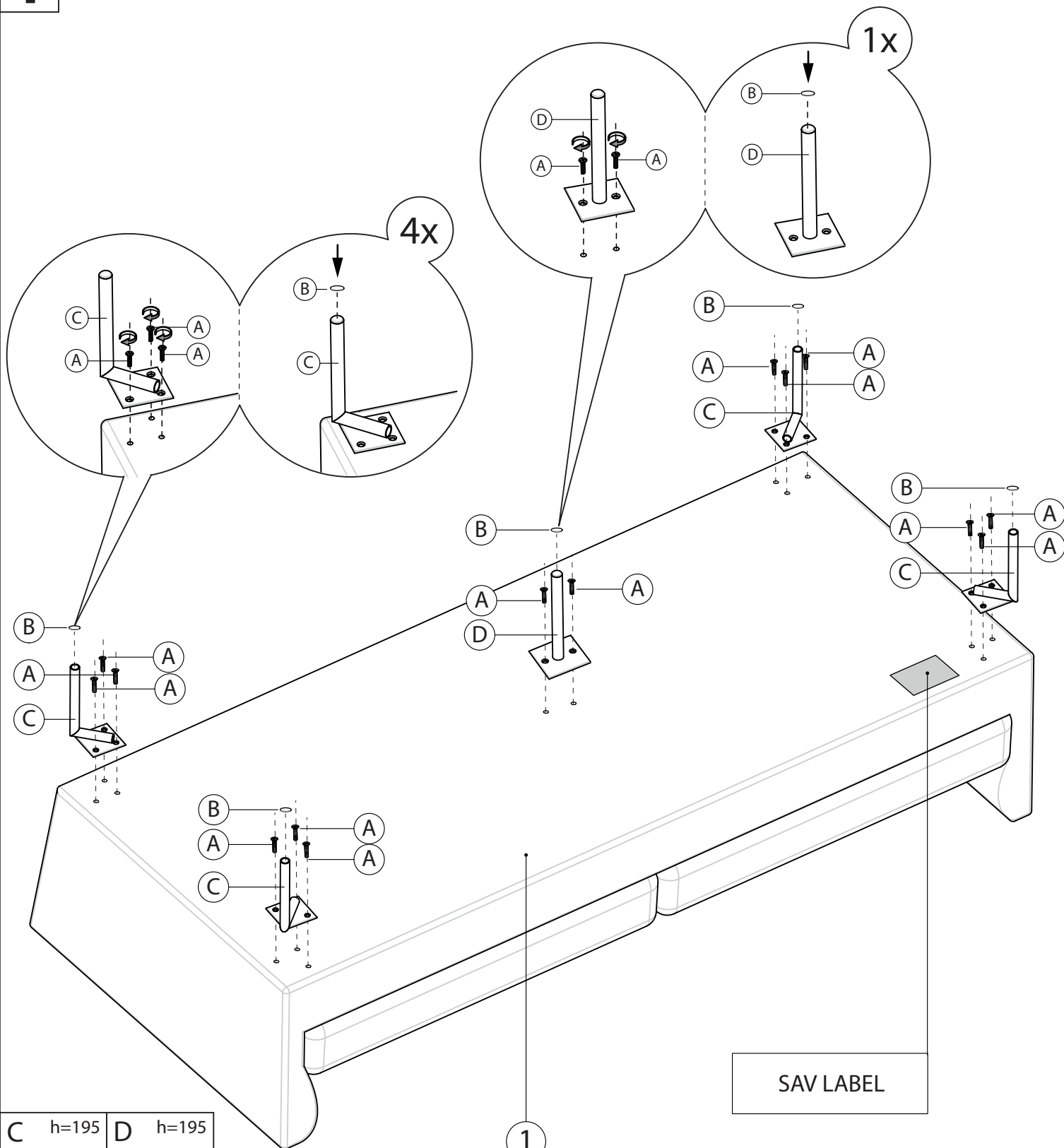

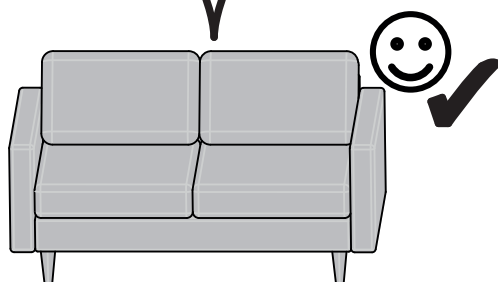
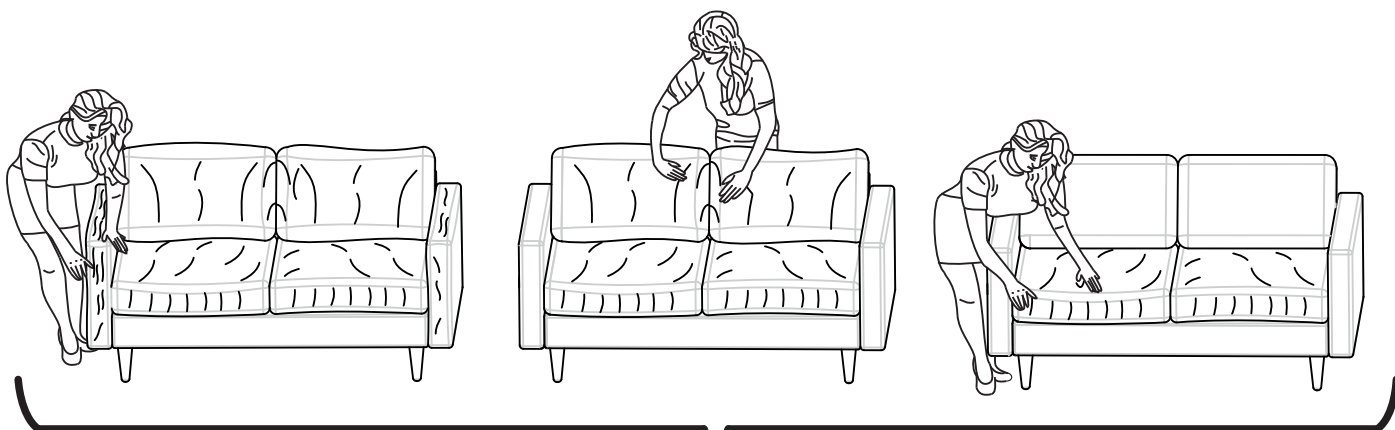
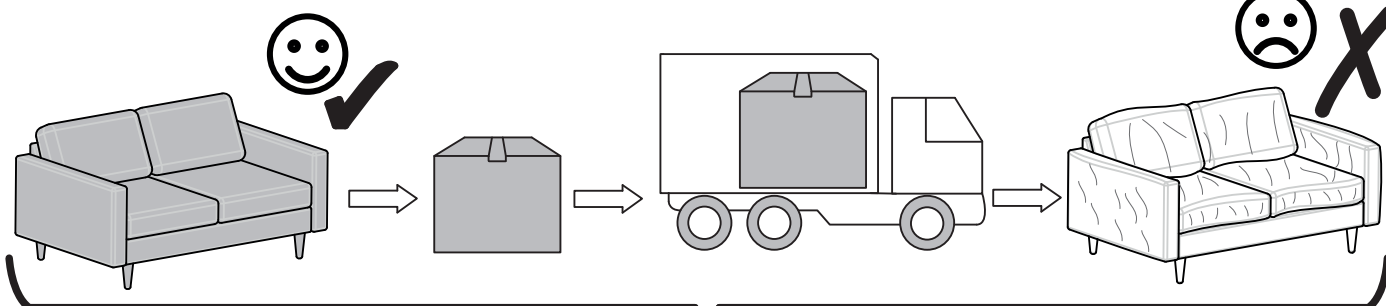
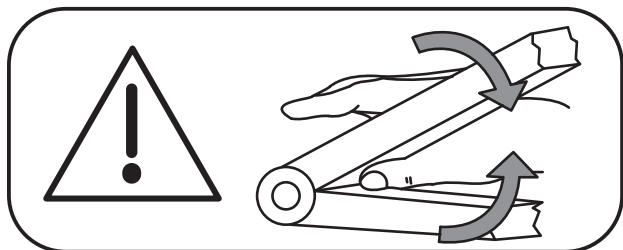
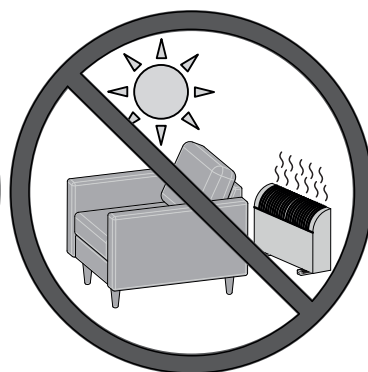

ENGLISH

ASSEMBLY ADVICE:

- CAREFULLY READ THE ASSEMBLY INSTRUCTION.
- IDENTIFY THE COMPONENTS OF THE FURNITURE.
- USE THE CORRECT TOOLS AND EQUIPMENT.
- USE THE REQUIRED TOOLS.
- CREATE AN ASSEMBLY ZONE.
- MAKE THE ASSEMBLY.

PAPER DECOR	LAMINATED SURFACES	LACQUERED SURFACES	WARMED WOOD	LEATHER TEXTILE
●	●	●	●	●
SOFT WATER (NEUTRAL SOAP)	●	●	●	●
WATER WITH DETERGENT	●	●	●	●
SPECIFIC SUPPLIER CLEANING	●	●	●	●

NEVER FORCE THE CONNECTIONS. RE-TIGHTEN THE SCREWS AFTER FEW DAYS. PLEASE RETAIN THE ALLELEIET FOR FUTURE REFERENCE. THE AI CONTAINS INFORMATION WHEN CLAIMING FOR MESSING PARTS.

NEVER USE ABRASIVE PRODUCTS OR SOLVENTS. DO NOT APPLY EXCESSIVE PRESSURE WHEN USING THE DAMP CLOTH.

DEUTSCH - SCHWEIZ

MONTAGE ANLEITUNG:

- DIE MONTAGEANLEITUNG SORGFÄLTIG DURCHLESEN.
- VERWENDEN SIE DIE RICHTIGEN WERKZEUGE.
- DIE BESCHLÄGE ZUSAMMENLEGEN UND PRÜFEN.
- DAS MONTAGEGEWISSE ZURECHTLEGEN.
- DEN MONTAGEBEREICH FREIMACHEN.
- DAS MONTAGESTÜCK ZUSAMMENBAUEN.

FEINPAPIER	ÜBERFLÄCHE LAMINIERT	ÜBERFLÄCHE LACK	LACKFERTIGES HOLZ	TEXTIL LEINER
●	●	●	●	●
WEICHES WASSER (NEUTRAL SEIFE)	●	●	●	●
WASSER MIT WÄSSERIGER REINIGER	●	●	●	●
SPEZIELLE REINIGER	●	●	●	●

MEINEN DIE VERBINDUNGEN ZU STARK ANZIEHEN. DIE SCHRAUBEN NACH EINIGER ZEIT DES GEBRAUCHS ERNEUT FESTZIEHEN. BEWAHREN: SOLLTE EIN TEIL FEHLEN, IST SIE DAS BESTE VERSTÄNDIGUNGS-MIT-TEIL MIT IHREM GESCHÄFT.

BRUCHEN SIE KEINE SCHEUERMITTEL WIE PULVER, STAHLWOLLE, LÖSUNGSMITTEL. KEIN WASSER VERWENDEN.

FRANÇAIS - SUISSE

CONSEILS DE MONTAGE:

- BEN ETUDIER LA NOTICE DE MONTAGE.
- REPRENEZ LES VIS APRES QUELQUES TEMPS D'USAGE. GARDER VOTRE NOTICE DE MONTAGE, SI UNE PIÈCE VENAIT À MANQUER, ELLE SERAIT LE PLUS CLAIR MOYEN DE COMMUNIQUER AVEC VOTRE MAGASIN.
- N'AMBIEN UTILISER DE PRODUITS ABRASIFS: POUDRE, LANE D'ACIER, SOLVANTS. NE PAS MOILLER.

PAPIER DÉCOR	SURFACES STRATIFIÉES	SURFACES LAQUÉES	BOS VERNIS	TEXTILE CUIR
●	●	●	●	●
EAU SAVONNEUSE (SAVON NEUTRE)	●	●	●	●
EAU AVEC DÉTERGENT LIQUIDE	●	●	●	●
PRODUIT DE NETTOYAGE SPÉCIFIQUE	●	●	●	●

NIE UŻYWAJ NADMIERNEJ SIŁY PODCZAS MONTAŻU. DOKRĘCZ ŚRUBY PO WŁIKU DNIAŁ. PROSZĘ ZACHOWAĆ ULOTKI AI NA PRZYSZŁOŚĆ. ALI ZAMIERA INFORMACJE POTRZEBNE DO ZŁOŻENIA BŁĄDZĄCYCH CZĘŚCI.

NIGDY NIE UŻYWAJ PRODUKTÓW ŚCIERNYCH LUB ZAMIERAJĄCYCH ROZPUŚCZALNIKI NIE WALEŻY NADMIERNE POCIERAĆ POWIERZCHNI MEBLA. PODCZAS UŻYWANIA, SZCERKA.

POLSKI

WSKAZÓWKI MONTAŻOWE:

- WALEŻY DOKŁADNIE PRZECZYTAĆ INSTRUKCJĘ MONTAŻU.
- DOKRĘCZAĆ ŚRUBY PO WŁIKU DNIAŁ. PROSZĘ ZACHOWAĆ ULOTKI AI NA PRZYSZŁOŚĆ. ALI ZAMIERA INFORMACJE POTRZEBNE DO ZŁOŻENIA BŁĄDZĄCYCH CZĘŚCI.
- NIGDY NIE UŻYWAJ PRODUKTÓW ŚCIERNYCH LUB ZAMIERAJĄCYCH ROZPUŚCZALNIKI NIE WALEŻY NADMIERNE POCIERAĆ POWIERZCHNI MEBLA. PODCZAS UŻYWANIA, SZCERKA.

PAPIER WYKONCZONY	POWIERZCHNIE LAMINOWANE	POWIERZCHNIE LAKIEROWANE	DRZEWO LAKIEROWANE	SZCERKA TRAWIARNA
●	●	●	●	●
WODA NEUTRALNA	●	●	●	●
WODA Z DETERGENTEM	●	●	●	●
CZYSZCZENIE SPECYFICZNE	●	●	●	●

NIE UŻYWAJ NADMIERNE SIŁY PODCZAS MONTAŻU. DOKRĘCZ ŚRUBY PO WŁIKU DNIAŁ. PROSZĘ ZACHOWAĆ ULOTKI AI NA PRZYSZŁOŚĆ. ALI ZAMIERA INFORMACJE POTRZEBNE DO ZŁOŻENIA BŁĄDZĄCYCH CZĘŚCI.

NIGDY NIE UŻYWAJ PRODUKTÓW ŚCIERNYCH LUB ZAMIERAJĄCYCH ROZPUŚCZALNIKI NIE WALEŻY NADMIERNE POCIERAĆ POWIERZCHNI MEBLA. PODCZAS UŻYWANIA, SZCERKA.

PORTUGUÊS

CONSELHOS DE MONTAGEM:

- ESTUDE BEM AS INSTRUÇÕES DE MONTAGEM.
- RETIHA AS PEÇAS QUE CONSTITUÍREM O SEU MÓVEL.
- USE O TEMPO DE UTILIZAÇÃO PARA REVISAR AS INSTRUÇÕES DE MONTAGEM.
- PREPARE UMA ÁREA PARA A MONTAGEM.
- INICIE A MONTAGEM.

ACABAMENTO EM PAPEL	SUPERFÍCIES ESTRATIFICADAS	SUPERFÍCIES LACADAS	MADERA ENVERNIZADA	TÉXTEIS PELES
●	●	●	●	●
ÁGUA COM SABÃO (SABÃO NEUTRO)	●	●	●	●
ÁGUA COM DETERGENTE	●	●	●	●
INSTRUÇÕES ESPECÍFICAS DO FABRICANTE	●	●	●	●

NUNCA FORÇAR OS ENCAIXES. REPARAR OS PARAFUSOS APÓS UM TEMPO DE UTILIZAÇÃO. GUARDAR AS INSTRUÇÕES DE MONTAGEM. CASO FALTE ALGUMA PEÇA, O MAIS ACONSELHÁVEL É CONTACTAR O REVENDEDOR.

NUNCA UTILIZAR PRODUTOS ABRASIVOS: SAPONICEDOS, LÁ DE AÇO, SOLVENTES. NÃO MOLHAR.

ITALIANO - SVIZZERA

CONSIGLI DI MONTAGGIO:

- STUDIARE BENE LE ISTRUZIONI DI MONTAGGIO.
- PREPARARE UN'AREA PER IL MONTAGGIO.
- PREPARARE UNA ZONA DI MONTAGGIO.
- PROCEDERE AL MONTAGGIO.

ACQUA CON SAPONE (SAPONE NEUTRO)	●	SUPERFICIE STRATIFICATE	●	SUPERFICIE LACCAE	●	LACCATO VERNICIATO	●	TESSILE CUOIO	●
DETERGENTE SANITARIO	●	●	●	●	●	●	●	●	●
MANUTENZIONE SPECIFICA PRODUTTORE	●	●	●	●	●	●	●	●	●

NON FORZARE MAI GLI ASSEMBLAGGI. RISTRINGERE LE VITI DOPO UN PERIODO DI USO. CONSERVARE QUESTE ISTRUZIONI DI MONTAGGIO. SE UN PEZZO VENISSE A MANCARE SAREBBE IL MIGLIORE MEZZO DI COMUNICAZIONE CON IL RIVENDITORE.

NON UTILIZZARE MAI PRODOTTI ABRASIVI: POLVERE, LANA DI ACCIAIO, SOLVENTI. NON BAGNARE.

ESPAÑOL

CONSEJOS PARA EL MONTAJE:

- ESTUDIE ATENTAMENTE EL MANUAL DE MONTAJE.
- LOCATE LAS PIEZAS QUE CONSTITUYEN SU MUEBLE.
- PREPARE UN ESPACIO PARA EL MONTAJE.
- PREPARE UNA ZONA DE MONTAJE.
- REALICE EL MONTAJE.

AGUA Y ABRON (ABON NEUTRO)	●	PAPIER DE DECORACION	●	SUPERFICIE ESTRATIFICADAS	●	SUPERFICIE AMARILLAS	●	MADERA BARNIZADA	●	TEJIL CUERO	●
AGUA CON DETERGENTE	●	●	●	●	●	●	●	●	●	●	●
MANTENIMIENTO ESPECIFICO DEL FABRICANTE	●	●	●	●	●	●	●	●	●	●	●

NO FUERCE NUNCA EN LAS UNIONES. APRIE LOS TORNILLOS DESPUES DE CIERTO TIEMPO DE UTILIZACION. CONSERVE SU MANUAL DE MONTAJE. SI FALTARA UNA PIEZA, SERA LA MANERA MAS FACIL DE COMUNICAR CON LA TIENDA.

NO USE NUNCA PRODUCTOS ABRASIVOS TALES COMO: POLVO DE LIMPIAR, LANA DE ACERO, SOLVENTES. NO MOJAR.

HRVATSKA

UPUTE ZA MONTAŽU:

- PAŽLJIVO PROČITAJTE UPUTE ZA MONTAŽU.
- PRIPRIJETE SVE DIOVE I NAMJEŠTAJA.
- PRIPRIJETE I PROVERITE OKOJE ZA MONTAŽU.
- PRIPRIJETE POTREBAN ALAT.
- PRIPRIJETE PROSTOR ZA MONTAŽU.
- POČINITE MONTIRATI.
- SACUVAJTE OVE UPUTE.
- PROIZVOĐ JE NAMENJEN ISKLJUČIVO ZA KUĆNO UPORABU.

OPINA SAPUNA	●	PAPIR	●	LAK	●	DRVO	●	TEKSTIL KOŽA	●
OPINA SAPUNA	●	●	●	●	●	●	●	●	●
NAMJERSKA SREDSTVA	●	●	●	●	●	●	●	●	●

NE MOJE UPOTREBLJIVATI SILU PRILIKOM SLAGANJA. NAKON NEKOG VREMENA PONOVNO PREGNITE VINE I OVAJE UPUTE ZA MONTAŽU I SUCUJ NEODSTAKA NEKOG RIEBA. NAJBOLJE JE HITI DA KONTAMINIRANO PRONAĐI MESTO.

ZABRANJENO JE UPOTREBA KEMIKALIJA I BLO KAKOVIH POMOĆNIH SREDSTAVA ZA REBANJE JAKIH SREDSTAV ZA OČISTENJE I ČEŠĆE VUNE NE MOŽRA.

TÜRKÇE

BAKIM TALIMATLARI:

- MONTAJI TAHHÜT YAPMADAN ÖNCE TALIMATLARI OKUYUNUZ.
- MONTAJI YAPMADAN ÖNCE BİR ZEMİN ALANINI HAZIRLAYINIZ.
- HER BİR ALAN İÇİN GEREKLİ ARAÇ VE ALATLARI HAZIRLAYINIZ.
- GEREKLİ ARAÇ VE GEREKİ YERLERİ HAZIRLAYINIZ.
- KENDİ MONTAJ ALANINI HAZIRLAYINIZ.
- MONTAJI EL VEYELERİ BAŞLAYINIZ.

SABUNLU SU (NÖTR SABUN)	●	SUS KAGIDI	●	KATMAN YIZEY	●	LAKE YIZEY	●	LAKE YIZEY	●	TEKSTİL DERI	●
DETERJAN KATMANLI SU	●	●	●	●	●	●	●	●	●	●	●
URETICIN ÖGÜSÜ BAKIM	●	●	●	●	●	●	●	●	●	●	●

MONTAJI TAHHÜT YAPMADAN ÖNCE TALIMATLARI OKUYUNUZ.
- MONTAJI YAPMADAN ÖNCE BİR ZEMİN ALANINI HAZIRLAYINIZ.
- HER BİR ALAN İÇİN GEREKLİ ARAÇ VE ALATLARI HAZIRLAYINIZ.
- GEREKLİ ARAÇ VE GEREKİ YERLERİ HAZIRLAYINIZ.
- KENDİ MONTAJ ALANINI HAZIRLAYINIZ.
- MONTAJI EL VEYELERİ BAŞLAYINIZ.

SRBIJA

SAVETI ZA MONTAŽU:

- PAŽLJIVO PROČITAJTE UPUTE ZA MONTAŽU.
- PRIPRIJETE SVE DIOVE I NAMJEŠTAJA.
- PRIPRIJETE I PROVERITE OKOJE ZA MONTAŽU.
- PRIPRIJETE POTREBAN ALAT.
- PRIPRIJETE PROSTOR ZA MONTAŽU.
- POČINITE MONTIRATI.
- SACUVAJTE OVE UPUTE.
- PROIZVOĐ JE NAMENJEN ISKLJUČIVO ZA KUĆNO UPOTREBU.

SABUNLU SU (NÖTR SABUN)	●	SUS KAGIDI	●	KATMAN YIZEY	●	LAKE YIZEY	●	LAKE YIZEY	●	TEKSTİL DERI	●
DETERJAN KATMANLI SU	●	●	●	●	●	●	●	●	●	●	●
URETICIN ÖGÜSÜ BAKIM	●	●	●	●	●	●	●	●	●	●	●

NE MOJE UPOTREBLJIVATI SILU PRILIKOM SLAGANJA. NAKON NEKOG VREMENA PONOVNO PREGNITE SPOVNE I OVAJE UPUTE ZA MONTAŽU I SUCUJ NEODSTAKA NEKOG RIEBA. NAJBOLJE JE IČE KONTAMINIRANO PRONAĐI MESTO.

ZABRANJENO UPOTREBA KEMIKALIJA I BLO KAKOVIH POMOĆNIH SREDSTAVA ZA REBANJE JAKIH SREDSTAV ZA OČISTENJE I ČEŠĆE VUNE NE MOŽRA.